

U 96

U-BOAT

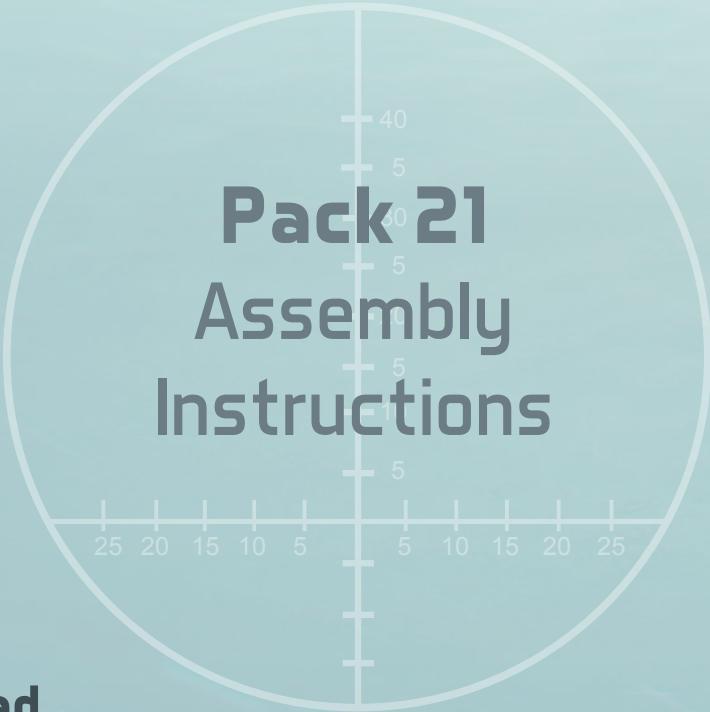

Pack 21 Assembly Instructions

Kit 81: A fourth magnet

Kit 82: Electric motor room bulkhead

Kit 83: Electric motor room deckhead

Kit 84: Main rudder motor



Hachette Partworks Ltd
4th Floor, Jordan House,
47 Brunswick Place, London, N1 6EB
www.U96-collection.com

© 2023/2024 Hachette Partworks Ltd.
ALL RIGHTS RESERVED
Not suitable for children under 14.

WARNING: All parts belong to a kit.
Collectors' item for adults. Not suitable for
children under 14. Some parts may have
sharp edges, please handle them with care.

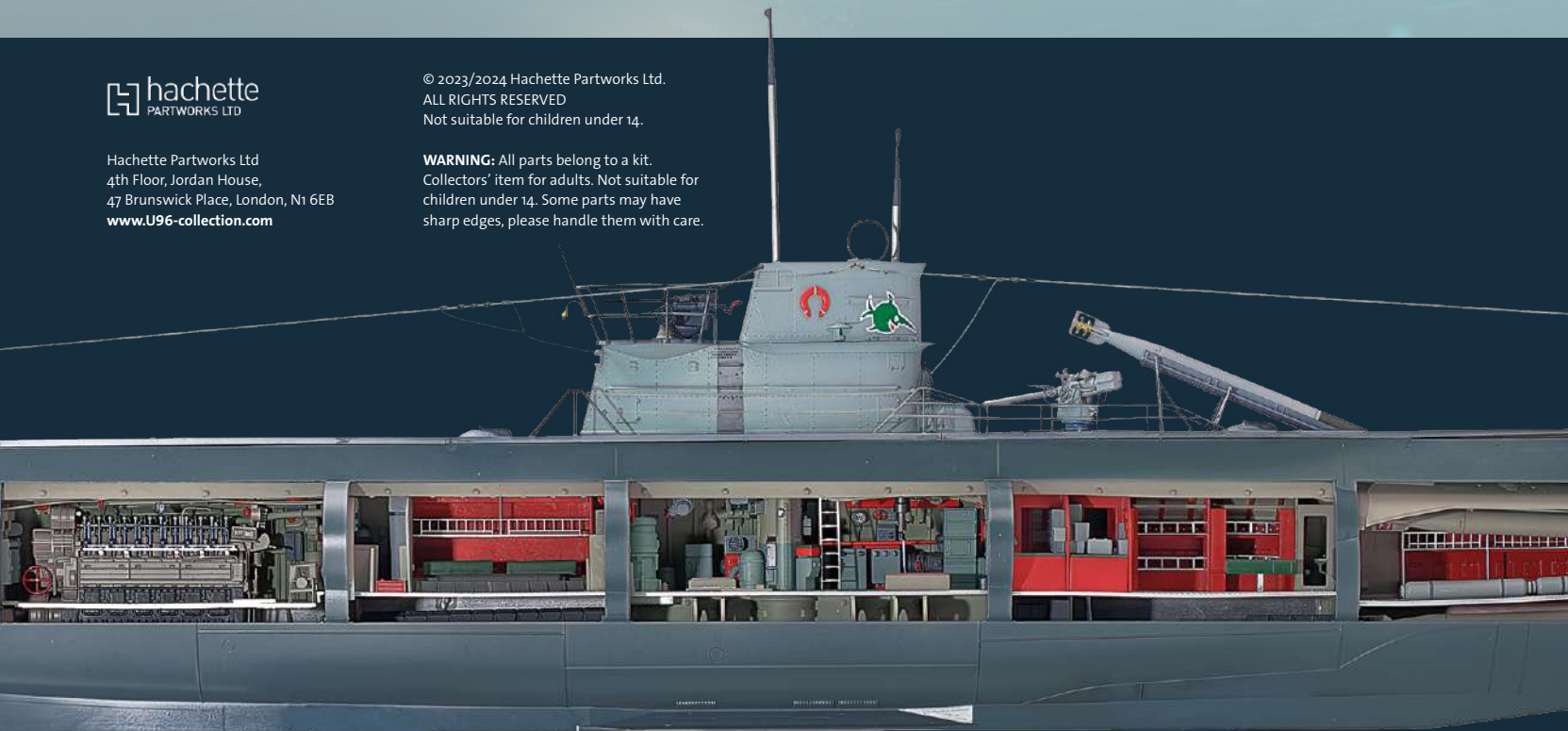

Kit 81: A fourth magnet

In this kit, the NCO accommodation compartment is added to the main assembly. Cabling is bundled together, a port (L) hull section is attached, and a fourth magnet with mounting plate and connectors is added to stabilise the structure.



Parts reference list	
Part no.	Name
81-1	Connector
81-2	Connector
81-3	Mounting plate
81-4	Cable guide
81-5	Crossbeam
81-6	Connector
81-7	Connector
81-8	Connector
81-9	Magnet

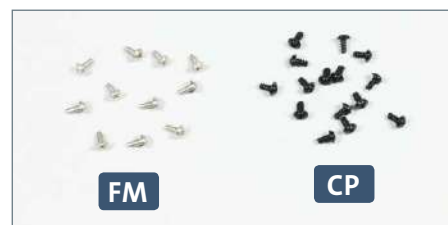

Screws		
Ref	No.	Dimensions
FM	10 + 1	2 x 4 mm (PWD)
CP	14 + 1	2 x 4 mm (PWB)

Kit 81: A fourth magnet

STAGE 1 → The hull and installation of the NCO quarters

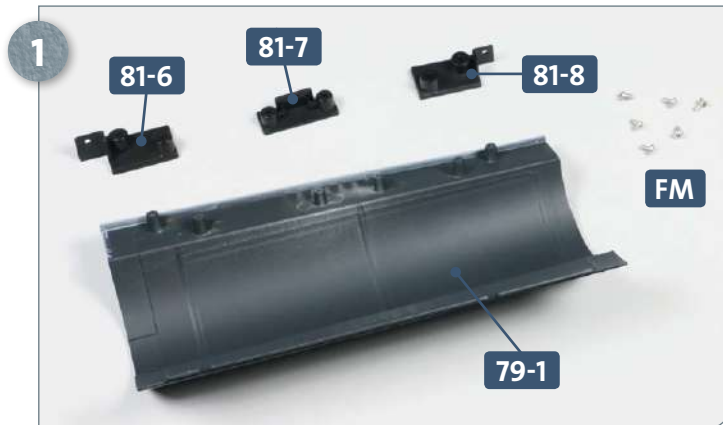

Take the port (L) hull section **79-1**, which was supplied with kit 79, the three connectors **81-6**, **81-7** and **81-8** and six **FM** screws. Arrange the parts as shown in the photograph above.

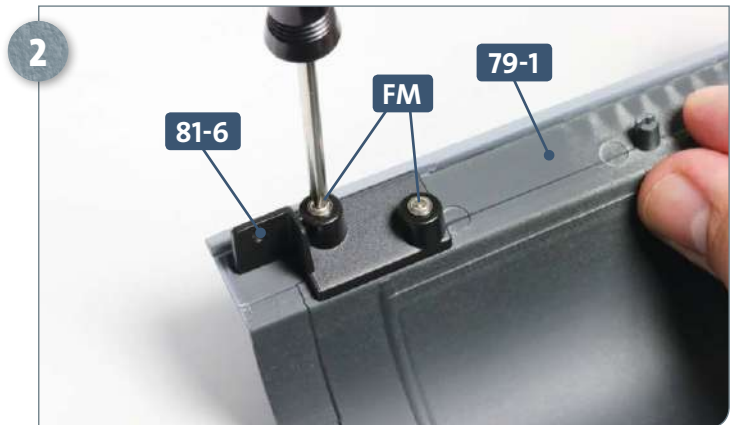

Attach the connector **81-6** to the aft end of the hull section **79-1** using two **FM** screws.

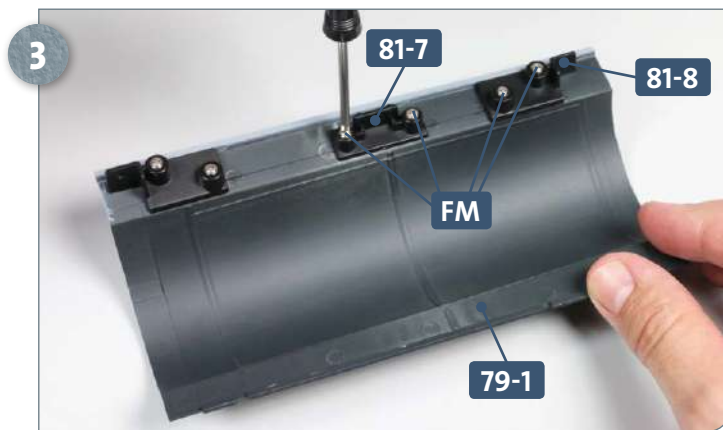

Next, attach connectors **81-7** and **81-8** to the hull section **79-1** using two **FM** screws for each.

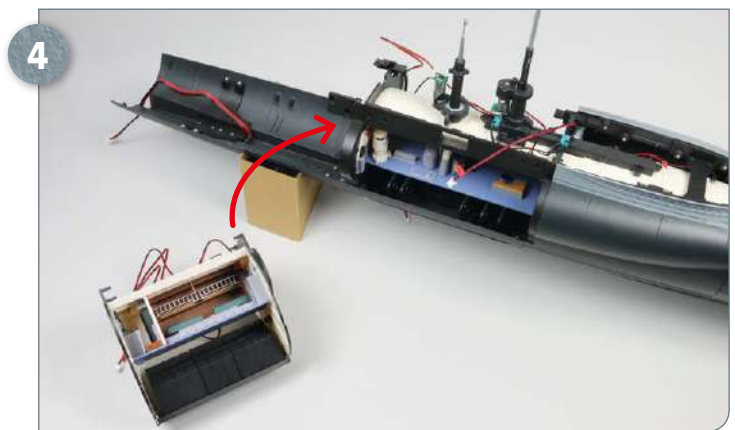

Place the hull assembly on your worktop. Now take the fourth compartment and insert it into the hull structure behind the third compartment, as indicated by the arrow.

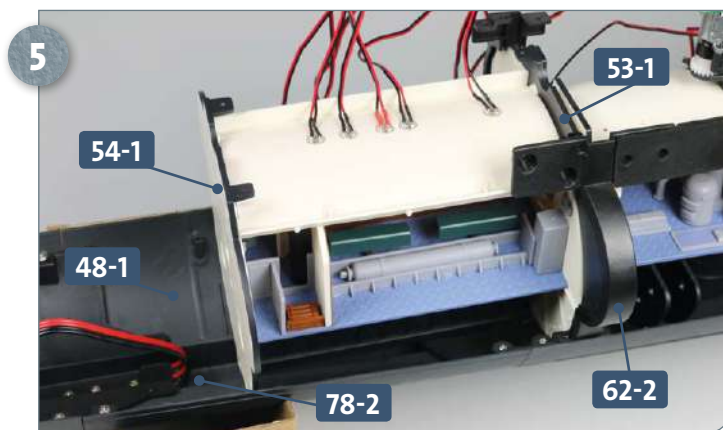

Place the fourth compartment inside the hull so that the forward bulkhead **53-1** sits in connector **62-2**, and the aft bulkhead **54-1** rests on the lower hull section **48-1**. Make sure that the connector wire **78-2** is tucked out of the way.

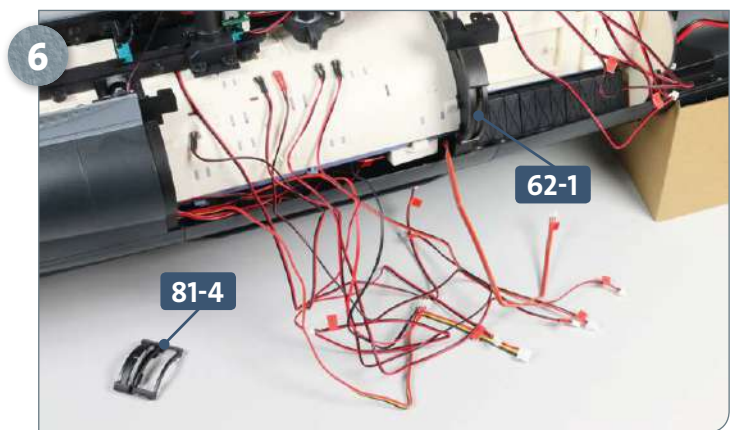

Turn the hull assembly round. You will continue work on connector **62-1**, which is located between the third and fourth compartments. Have ready the cable guide **81-4**.

Kit 8!: A fourth magnet

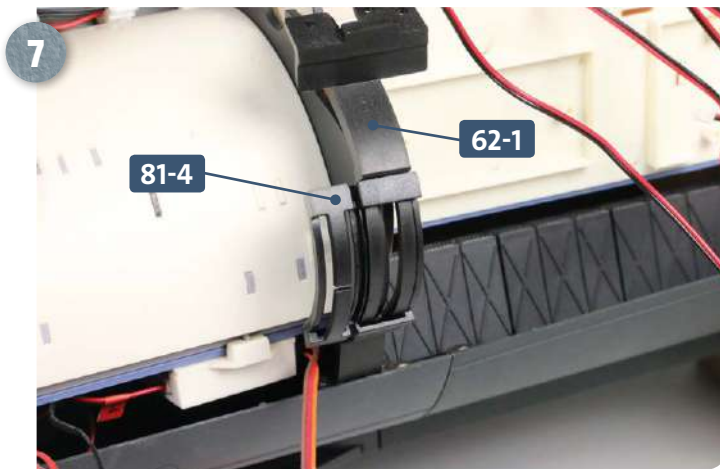

Clip the cable guide **81-4** onto the connector **62-1**.

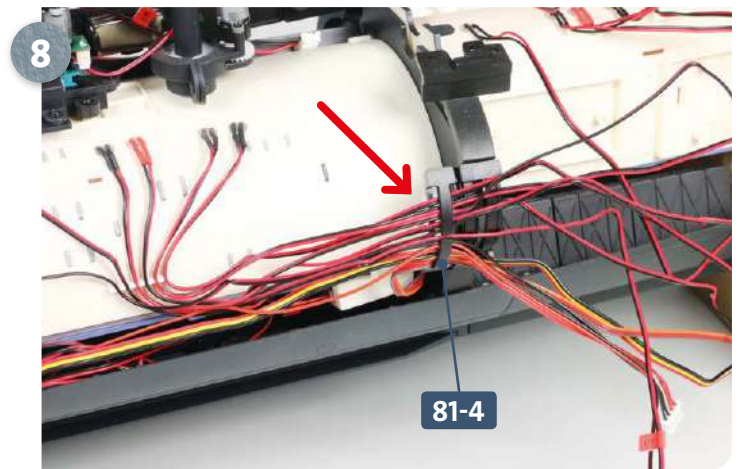

Guide the cables running along the lower part of the third compartment through the cable guide (as indicated by the arrow) one after the other. There is a small gap in the middle of guide **81-4** through which the cables pass.

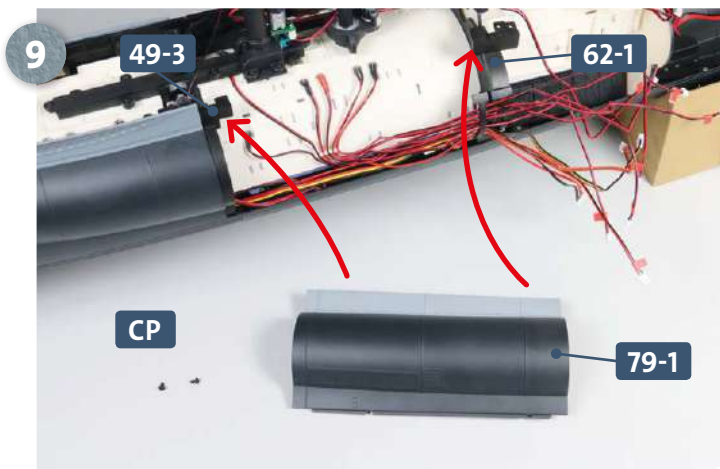

Have ready the left hull section **79-1** and two **CP** screws. Place the hull section level with the third compartment, between connectors **49-3** and **62-1**, as indicated by the arrows.

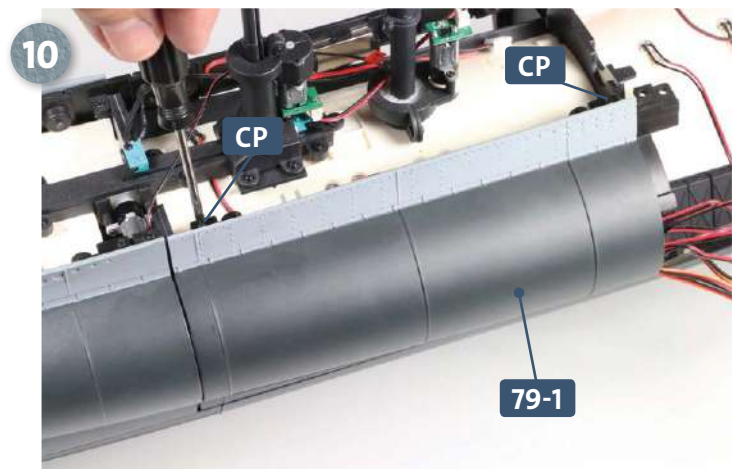

Attach the hull section **79-1** to the two connecting parts using one **CP** screw at each end, as shown above.

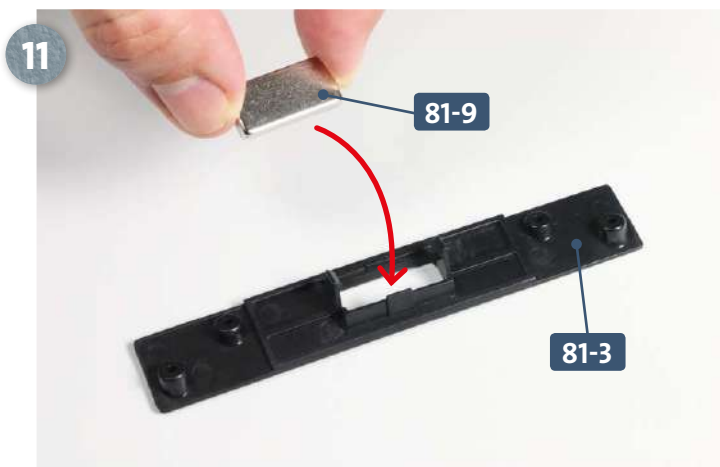

Place the mounting plate **81-3** back-side on your work surface. Take the magnet **81-9** and slot it into its holder on the mounting plate, as pictured.

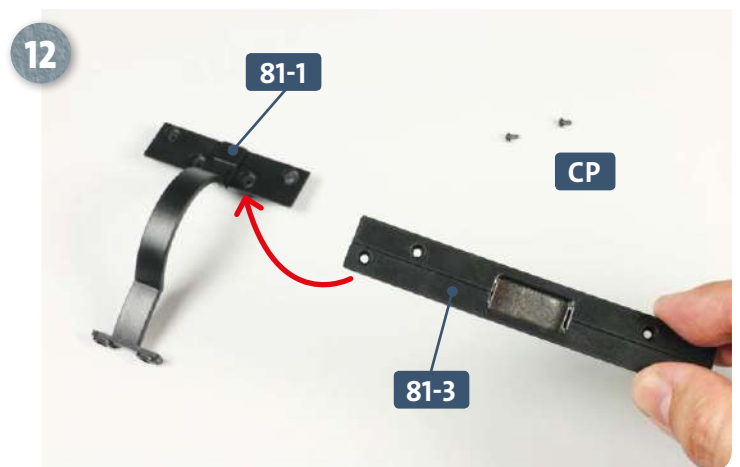

Place the aft end of the mounting plate **81-3** on the connector **81-1**, as indicated by the arrow. Have ready two **CP** screws.

Kit 81: A fourth magnet

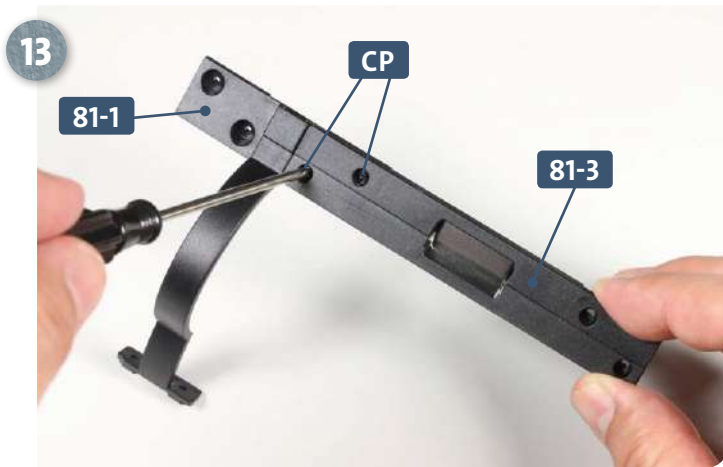

Fasten the mounting plate **81-3** to the connector **81-1** using two **CP** screws, as shown.

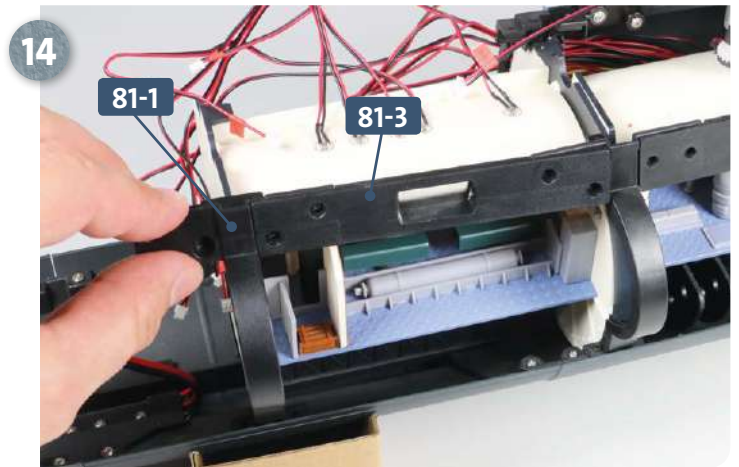

Turn the model round again so that the starboard (R) side may be accessed. Insert the mounting plate **81-3** into the connector at the forward end of the fourth compartment and attach the connector **81-1** at the aft end, as shown.

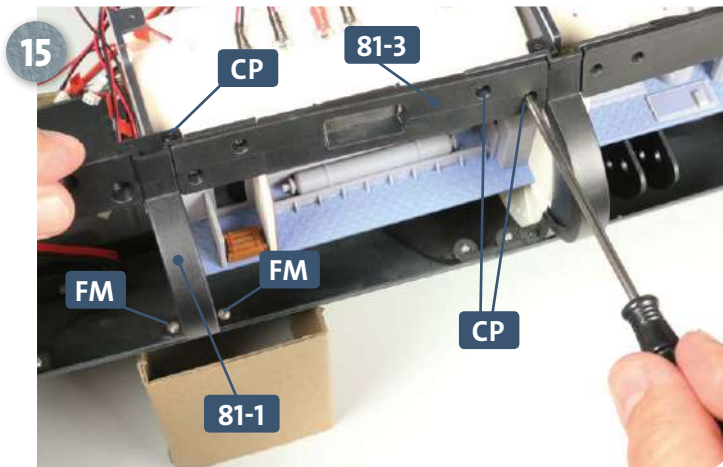

Fix the mounting plate **81-3** in place using two **CP** screws. The connector **81-1** is then attached using one **CP** screw and two **FM** screws as shown in the photo.

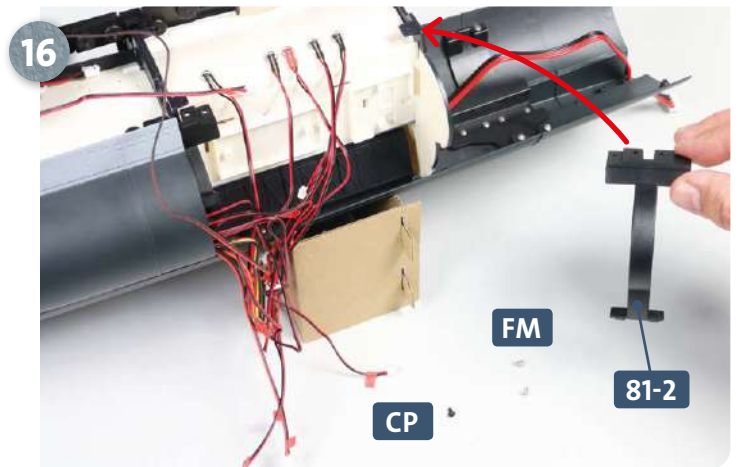

Move now to the port (L) side of the hull. Have ready two **FM** screws and one **CP** screw. Taking connector **81-2**, fit it onto the aft bulkhead of the fourth compartment, as indicated by the arrow.

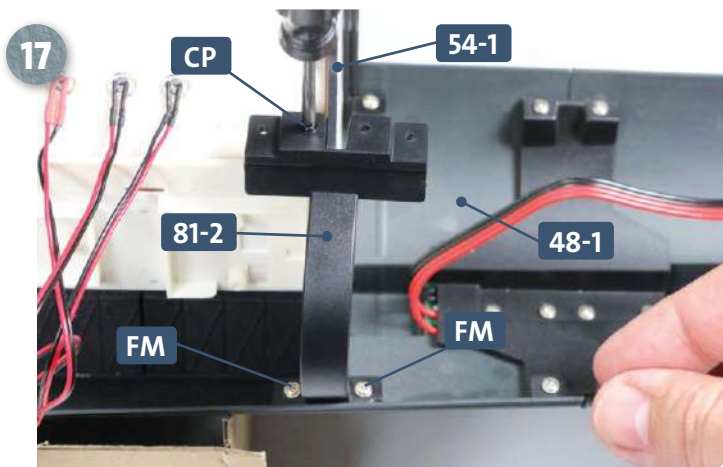

Attach the connector **81-2** to the bulkhead **54-1** using one **CP** screw and two **FM** screws into the hull section **48-1**.

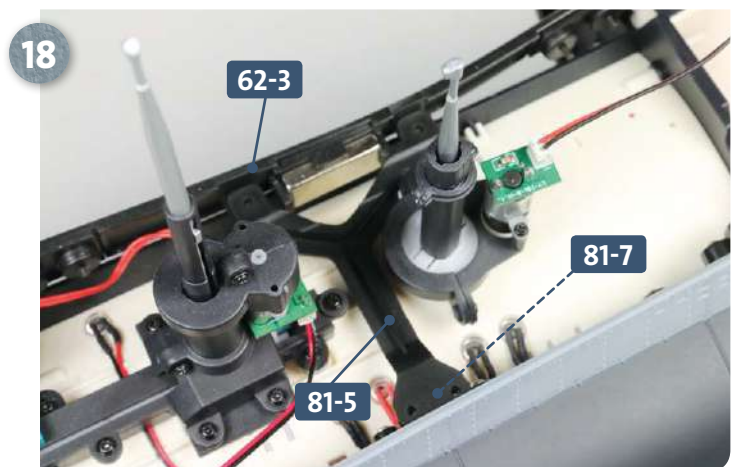

The crossbeam **81-5** goes across the deckhead of the third compartment, bridging connector **81-7** with mounting plate **62-3**, as pictured above.

Kit 8: A fourth magnet

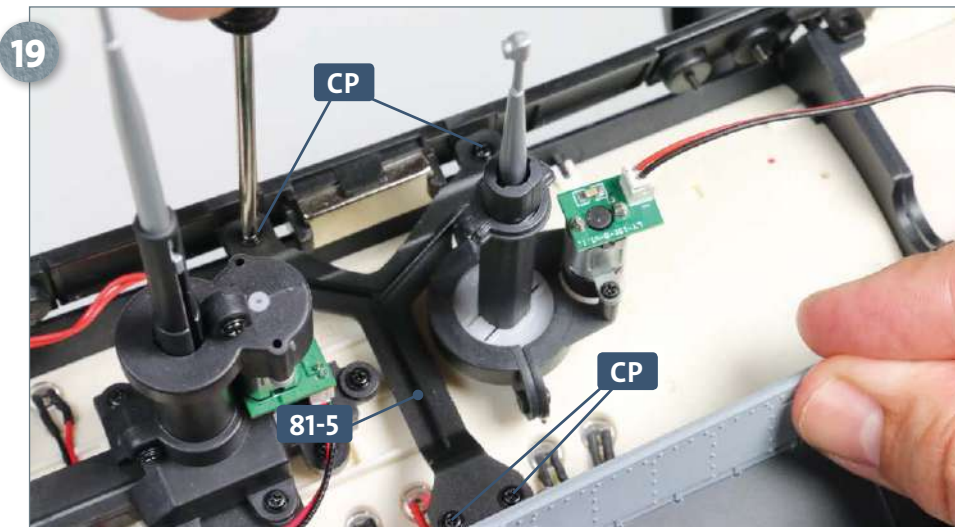

Fix the crossbeam 81-5 in place using four CP screws, as shown.

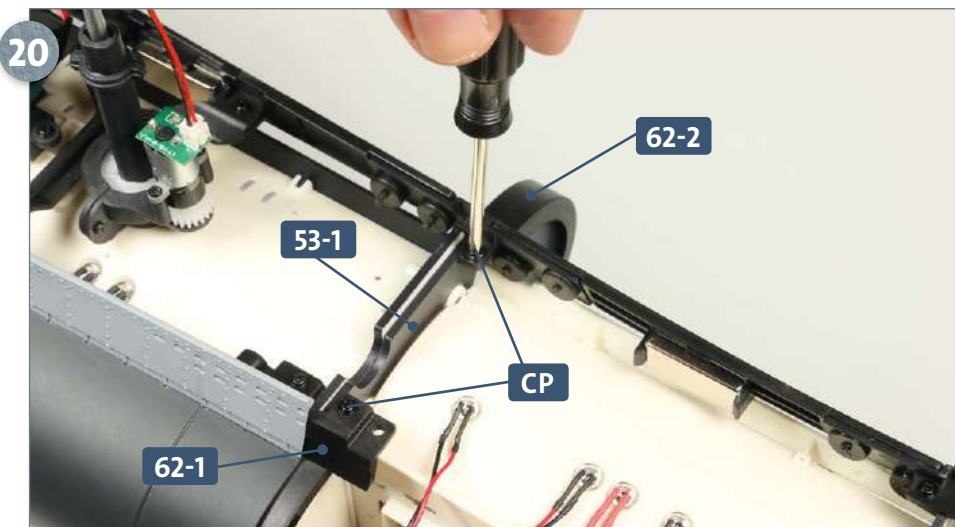

Fix connectors 62-1 and 62-2 to the forward bulkhead of the fourth compartment 53-1 using one CP screw for each.

COMPLETED WORK

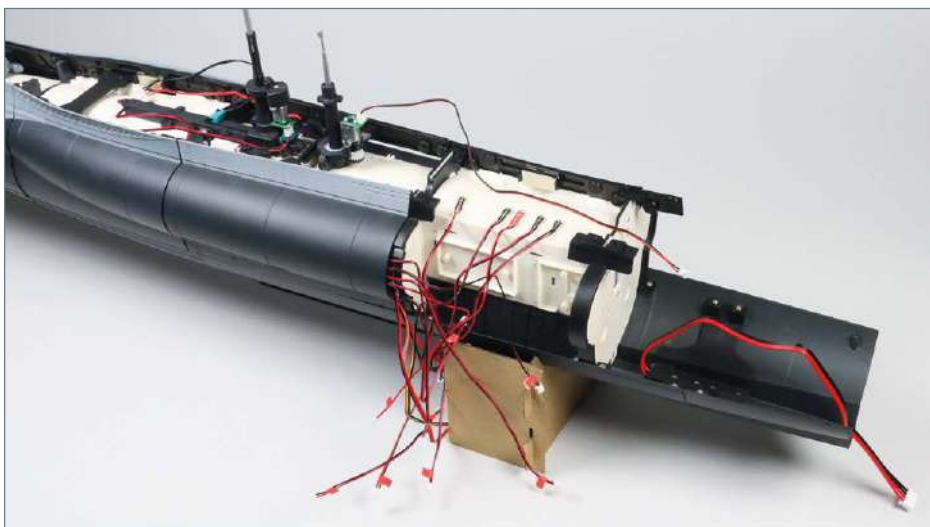

Work on the main hull section has progressed, with the addition of the fourth compartment, a hull plate and various connecting parts.

Kit 82: Electric motor room bulkhead

In this kit, you will begin work on the electrical motor and aft torpedo room, attaching handwheels, a fire extinguisher and other attachments including a soundproof door to the forward bulkhead.

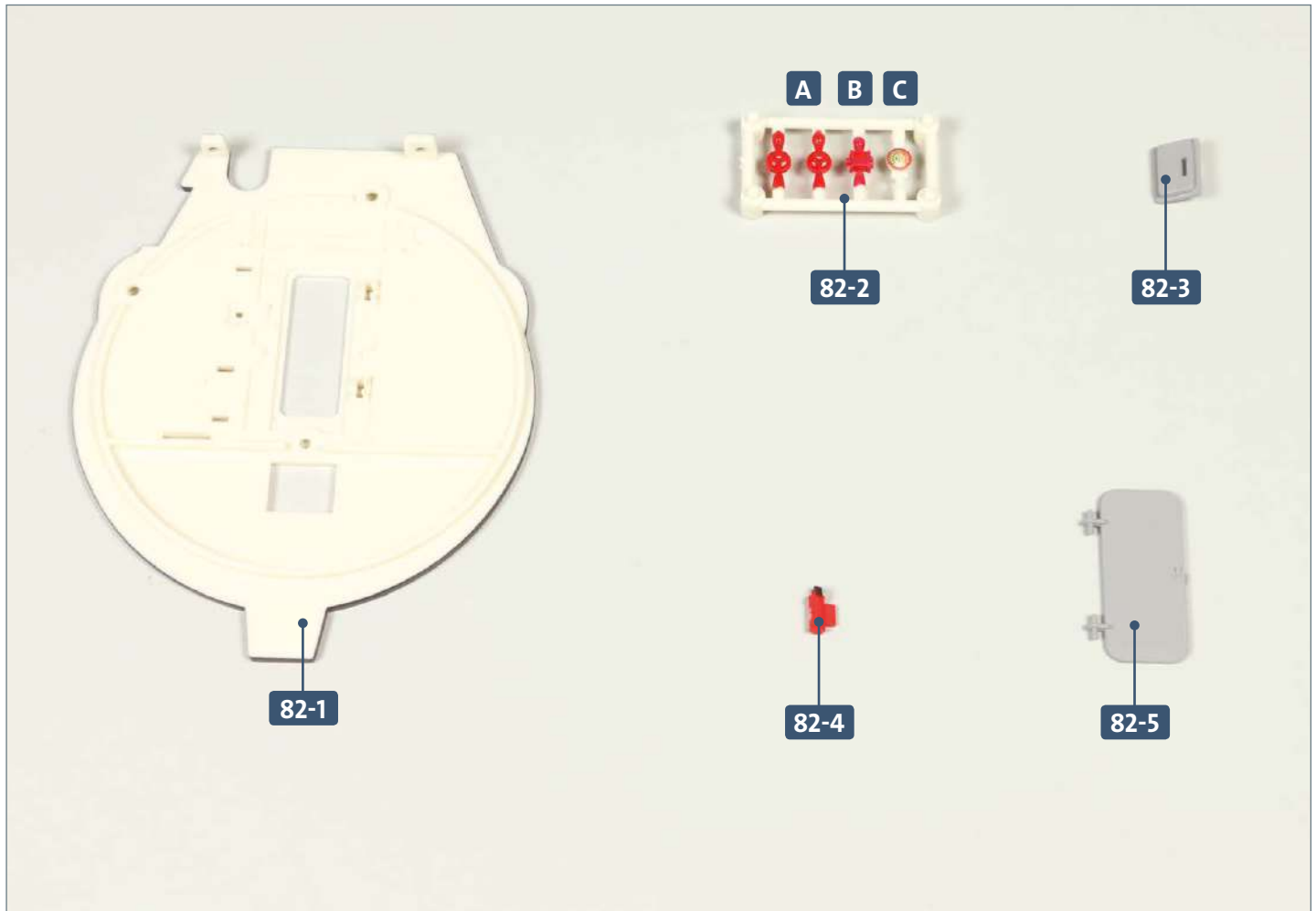

Parts reference list	
Part no.	Name
82-1	Forward bulkhead (electric motor room)
82-2	Frame (2 x A, B, C)
82-3	Fire extinguisher bracket
82-4	Fire extinguisher
82-5	Soundproof door

STAGE 1 → Forward bulkhead

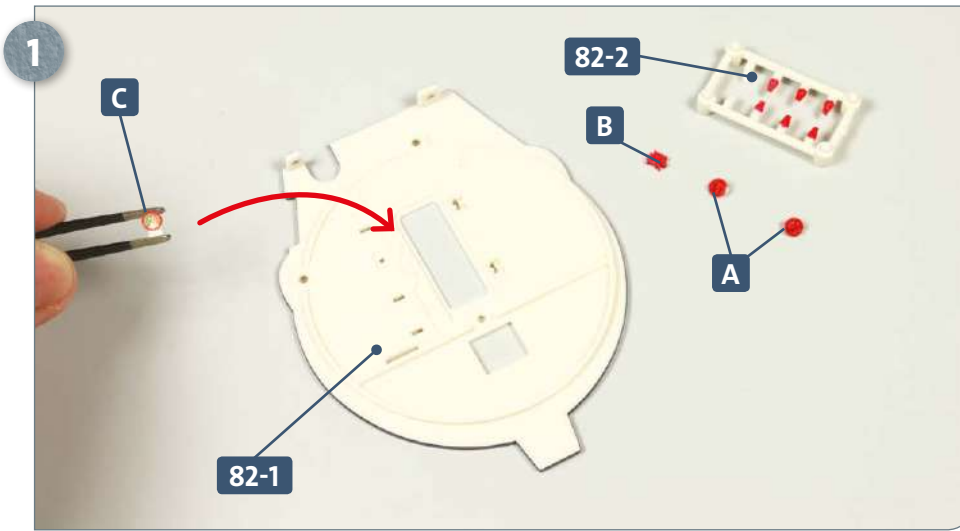

Take the forward bulkhead **82-1** and frame **82-2**. Detach the four pieces from the frame, as shown. Take part **C**, apply a little glue to the peg on the back and insert it into the slot indicated by the arrow, left.

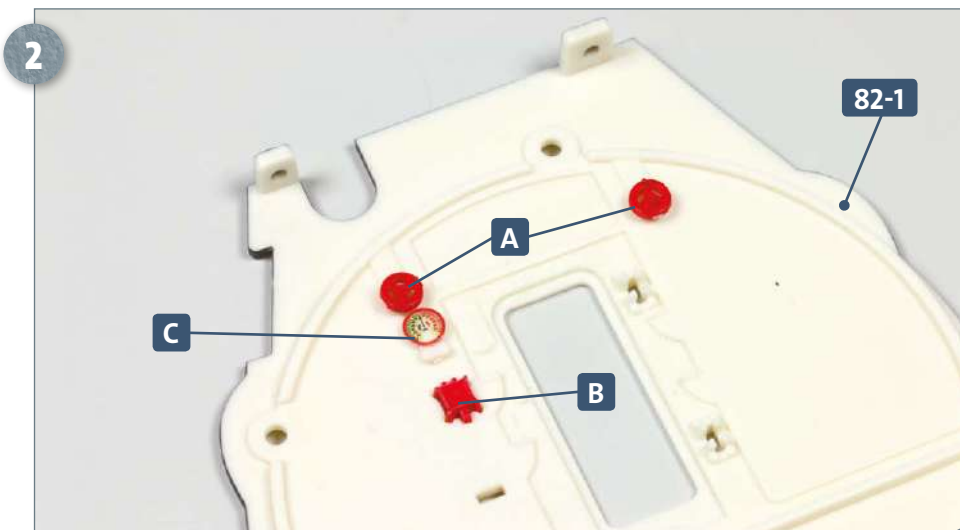

Next, glue the two handwheels **A** and attachment **B** to the bulkhead **82-1** as pictured, left.

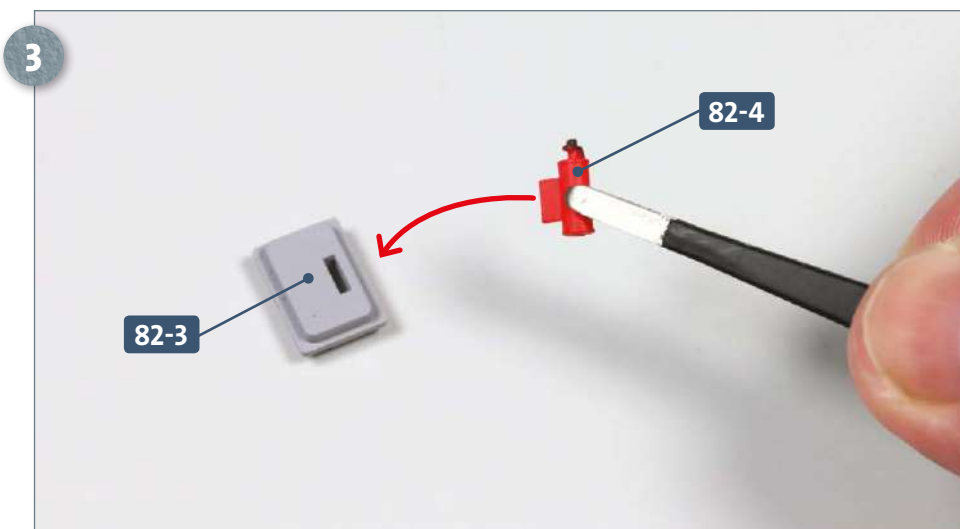

Take the fire extinguisher **82-4**. Apply some glue to the peg and insert it into the slot of the bracket **82-3**, as shown by the arrow.

Kit 82: Electric motor room bulkhead

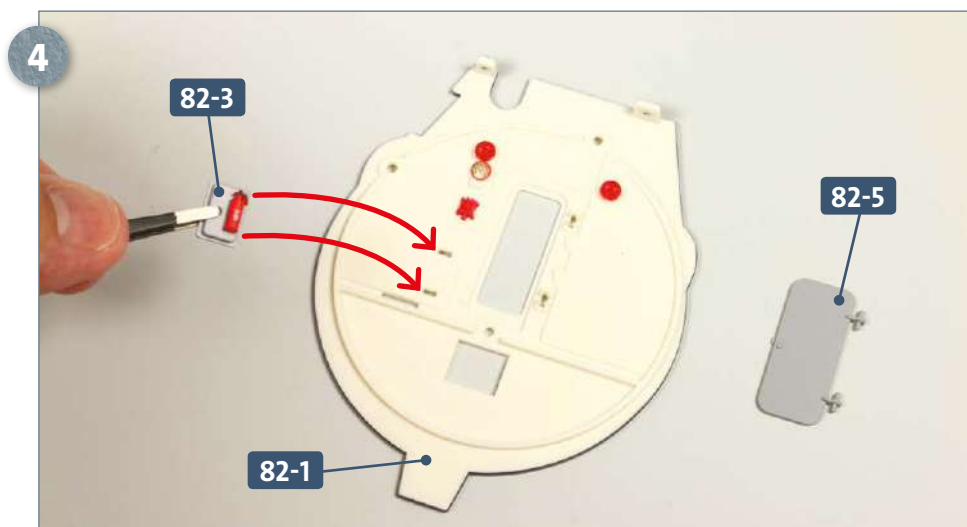

Apply some glue to the two pegs on the back of the bracket **82-3** and insert them into the corresponding slots in the bulkhead **82-1**, as indicated by the arrows. Have ready the soundproof door **82-5**.

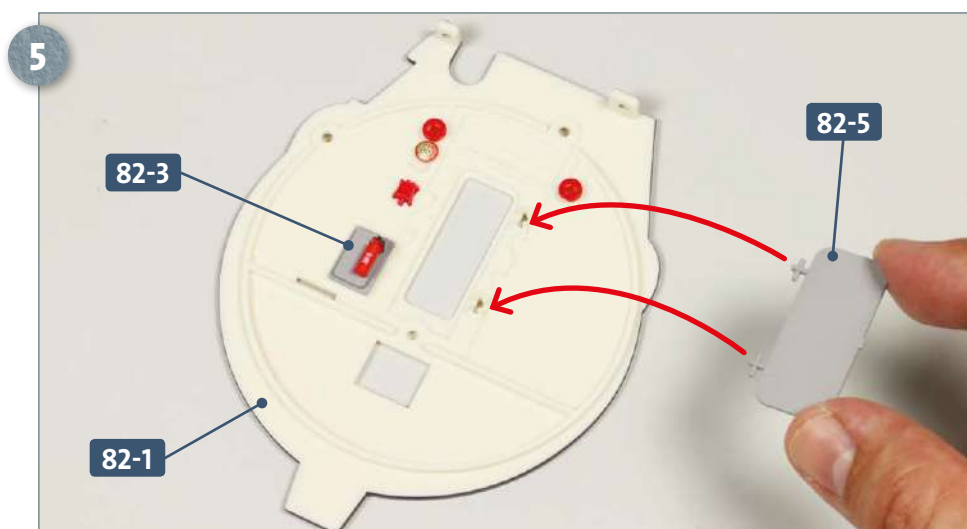

Glue the bracket **82-3**, and attached fire extinguisher onto the bulkhead as pictured. Take the soundproof door **82-5**, and push-fit its hinges into their mounts on the bulkhead **82-1**, shown by the arrows.

COMPLETED WORK

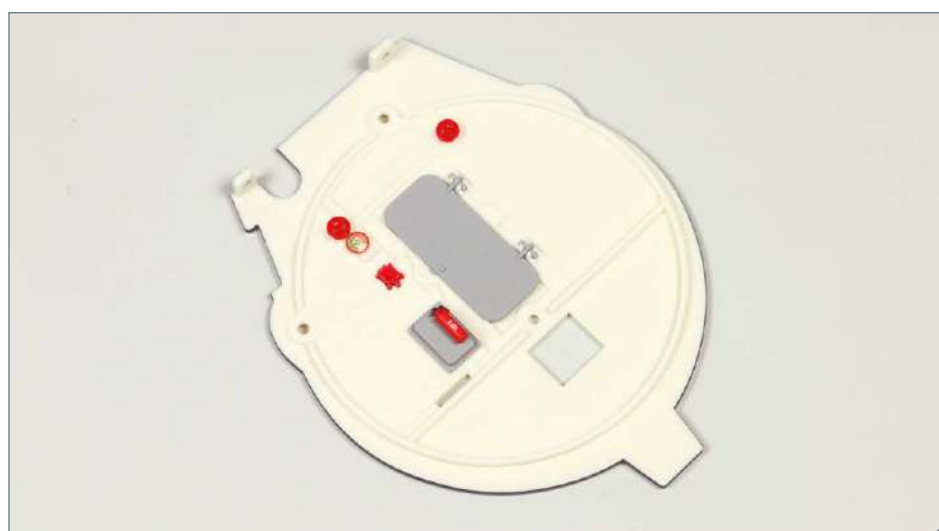

The forward bulkhead for the electric motor room has now been furnished with various attachments.

Kit 83: Electric motor room deckhead

In this kit, work on the electric motor room continues with the deckhead. Converters, a telegraph and other attachments are fixed to the deckhead.

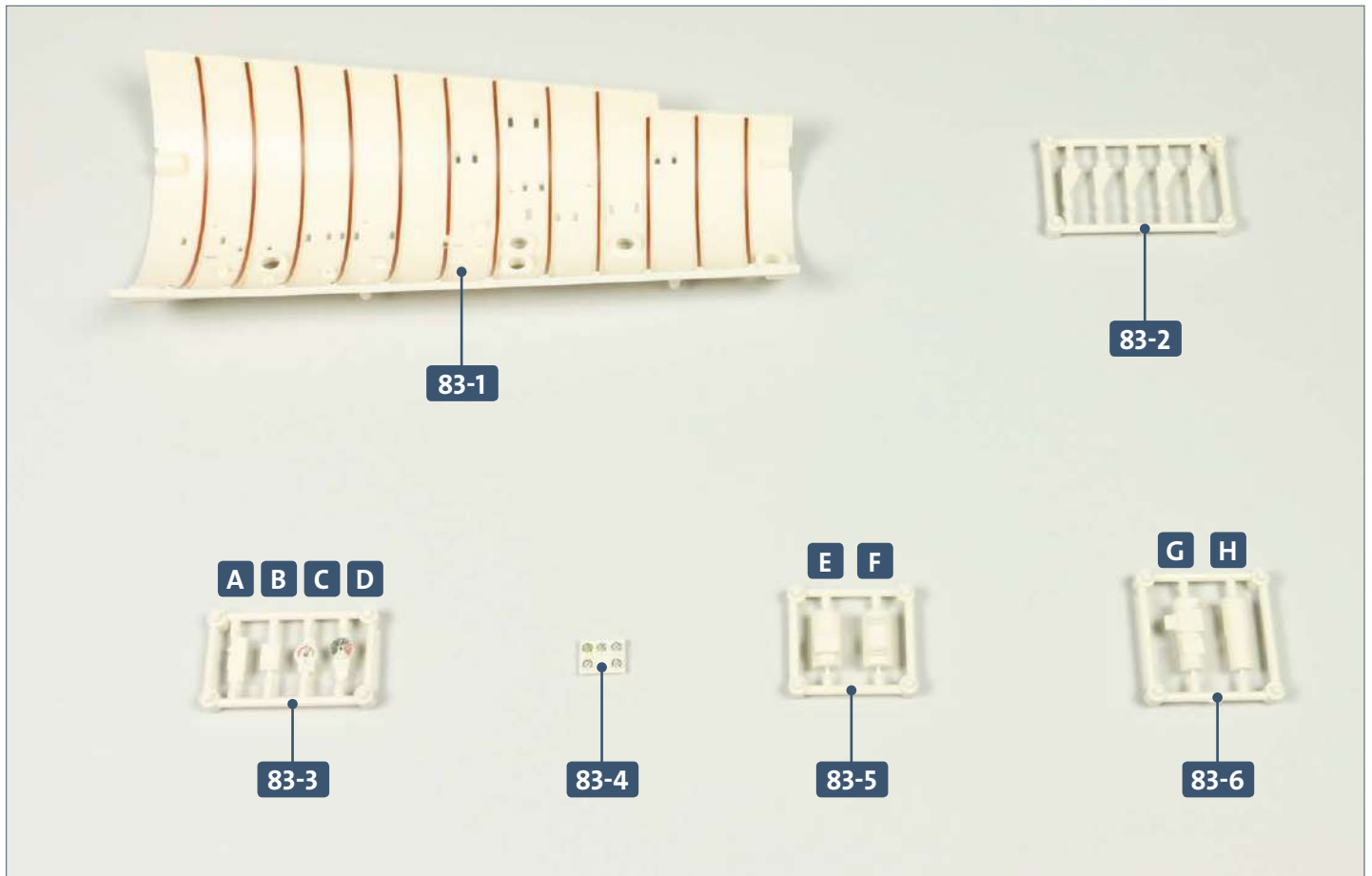

Parts reference list	
Part no.	Name
83-1	Electric motor room deckhead
83-2	Converter brackets
83-3	Frame (A, B, C, D)
83-4	Pressure gauge
83-5	Converter (E, F)
83-6	Converter (G, H)

Kit 83: Electric motor room deckhead

STAGE 1 → Electric motor room deckhead

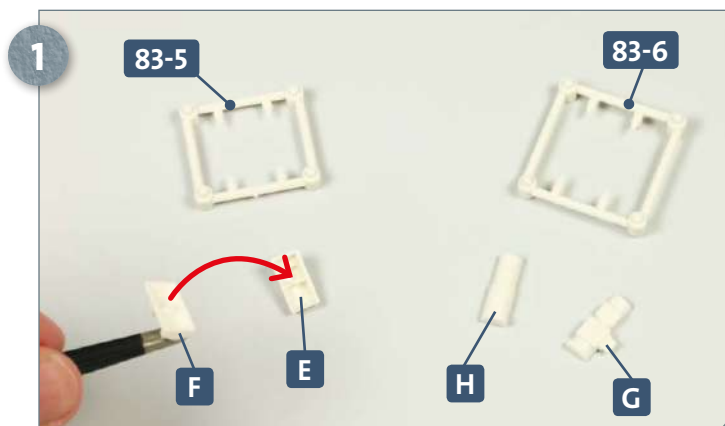

Take frames **83-5** and **83-6**. Detach the converter parts **E**, **F**, **G** and **H** from the frames. Apply a little glue to the raised socket of **F** and fit it onto the peg of part **E**, as indicated.

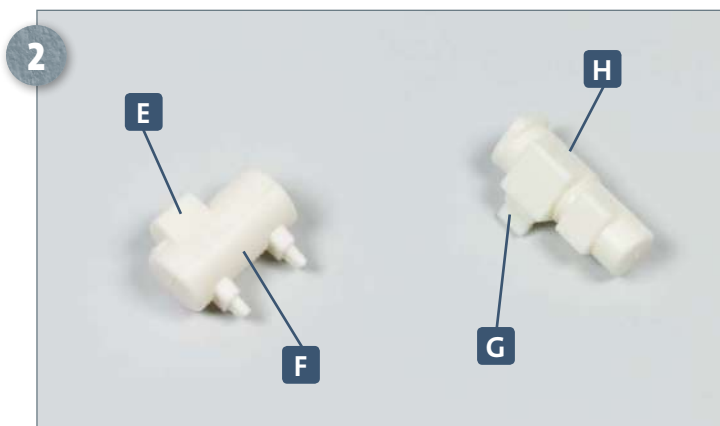

Parts **E** and **F** form the first converter. After test-fitting, repeat the process to join **G** and **H** and create the second converter, as pictured above.

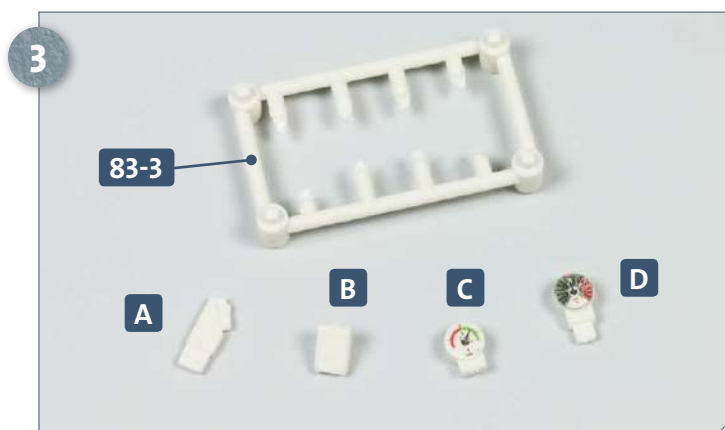

Detach parts **A**, **B**, **C** and **D** from frame **83-3**, as shown.

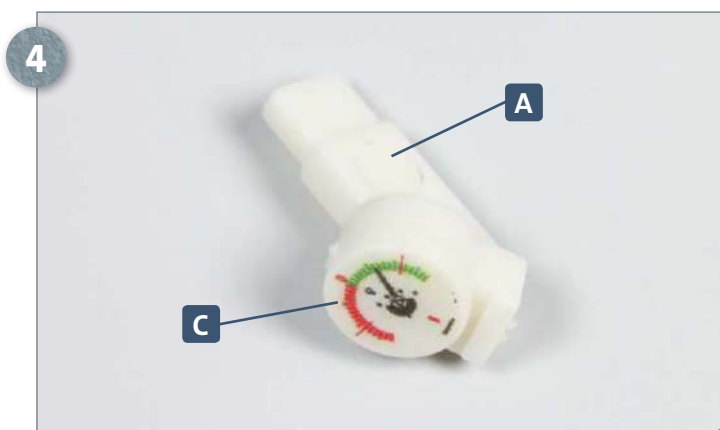

Apply some glue to the wider peg of part **A** and insert it into the slot on the back of the display, **C**.

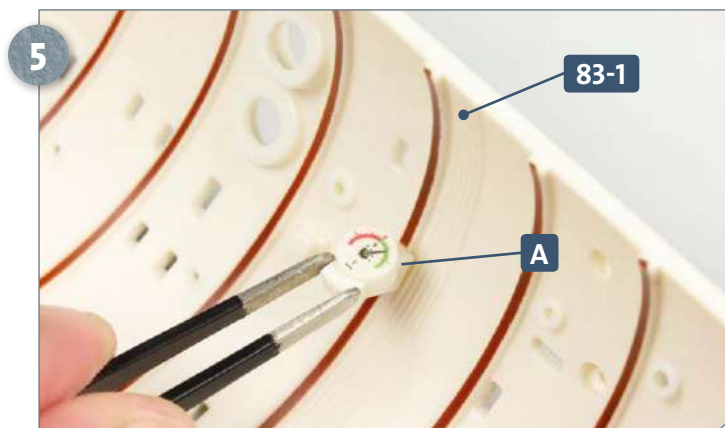

Apply some glue to the end of part **A** and insert into the recess in the deckhead panel **83-1** as shown.

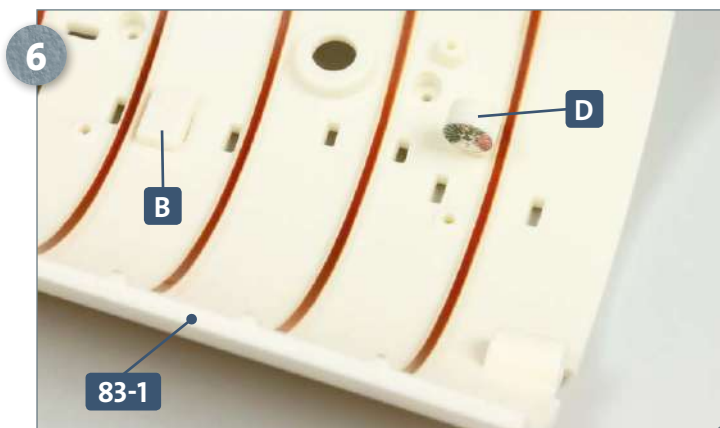

Glue part **B** and the telegraph (**D**) to the forward end of the deckhead **83-1**, as pictured.

Kit 83: Electric motor room deckhead

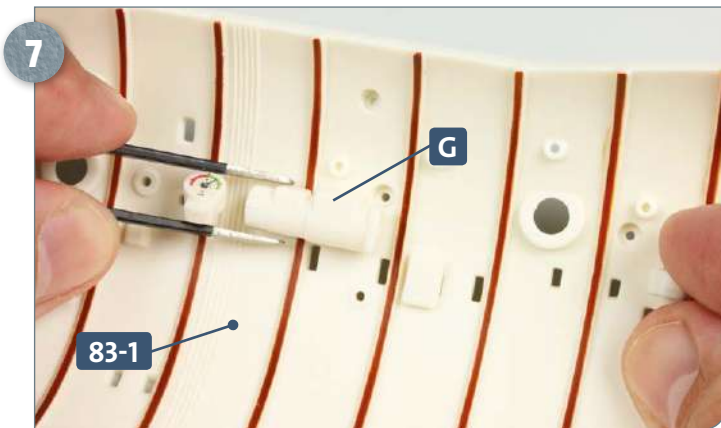

Take the longer of the two assembled converters, apply some glue to the peg of part **G** and insert it into the slot on the deckhead panel **83-1**.

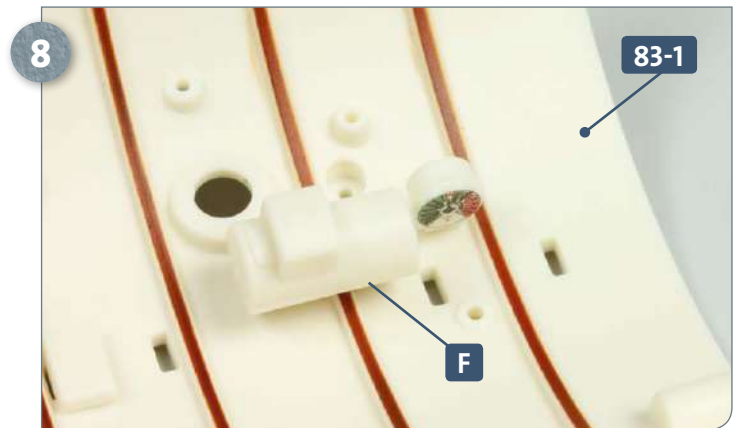

Apply some glue to the two pegs on the back of the second converter **F** and insert them into the two slots in the forward section of the deckhead panel **83-1**.

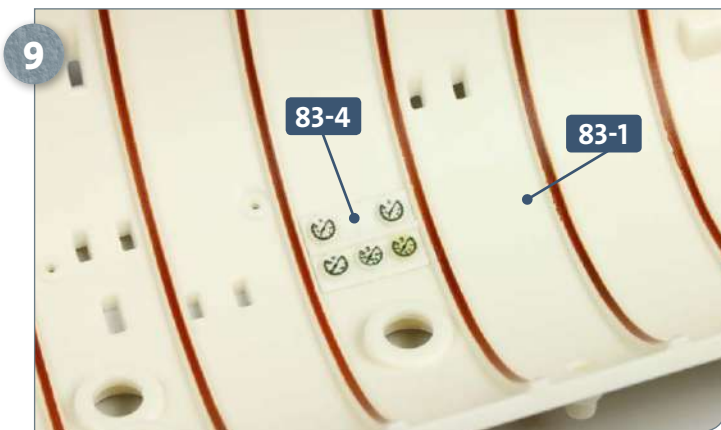

Take the pressure gauge **83-4**. Apply some glue to the back, and glue it in the position shown above at the aft end of the deckhead panel **83-1**.

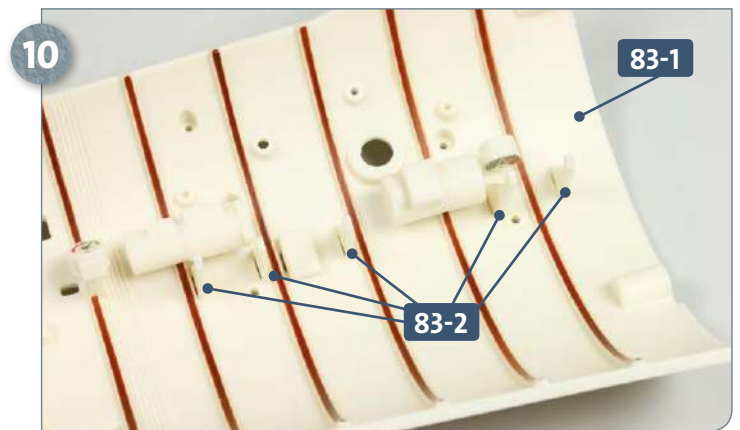

Glue the five brackets **83-2** to the forward section of the deckhead **83-1**, as pictured.

COMPLETED WORK

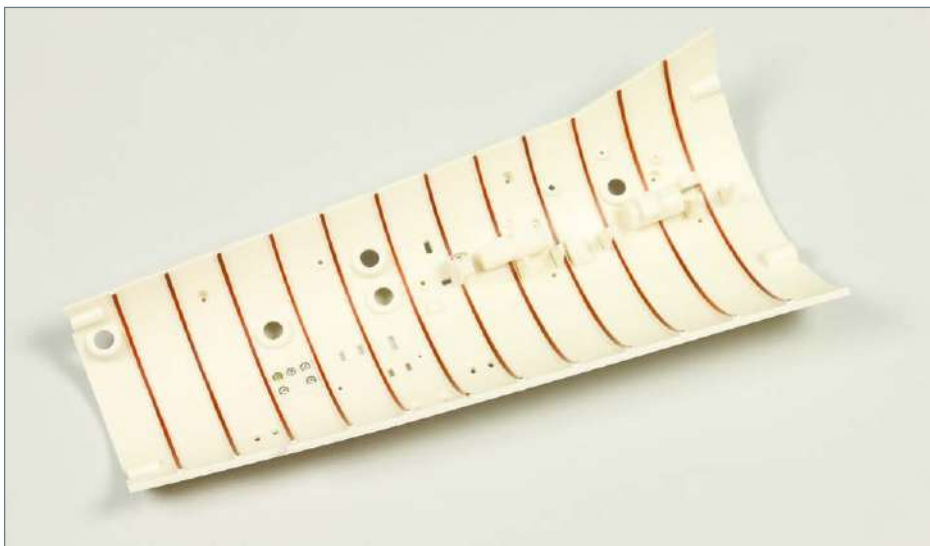

Two converters and various other components have been attached to the deckhead of the electric motor room.

Kit 84: Main rudder motor

In this kit, various components are added to the deckhead of the electric motor room, including power and compressed air lines, control rods and various other attachments. The main rudder motor is assembled and fitted with drive shafts.

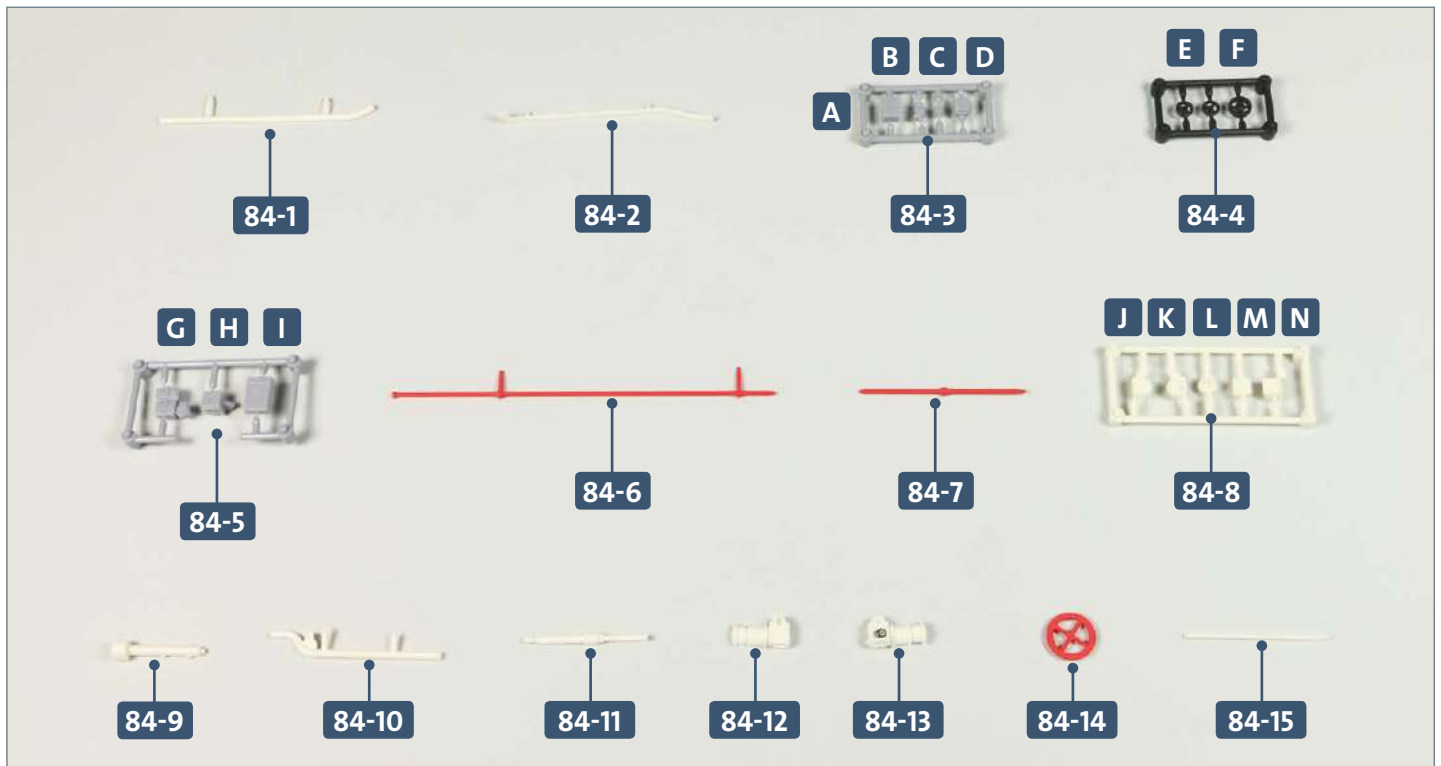

Parts reference list	
Part no.	Name
84-1	Compressed air line
84-2	Power line
84-3	Attachments (A, B, C, D)
84-4	Handwheels (2 x E, F)
84-5	Attachments (G, H, I)
84-6	Control rods for ventilation system
84-7	Control rods for ventilation system
84-8	Attachments (J, K, L, M, N)
84-9	Emergency rudder column
84-10	Compressed air line
84-11	Drive shaft
84-12	Main rudder motor
84-13	Main rudder motor
84-14	Emergency rudder hand wheel
84-15	Drive shaft

STAGE 1 → Motor room deckhead and main rudder motor

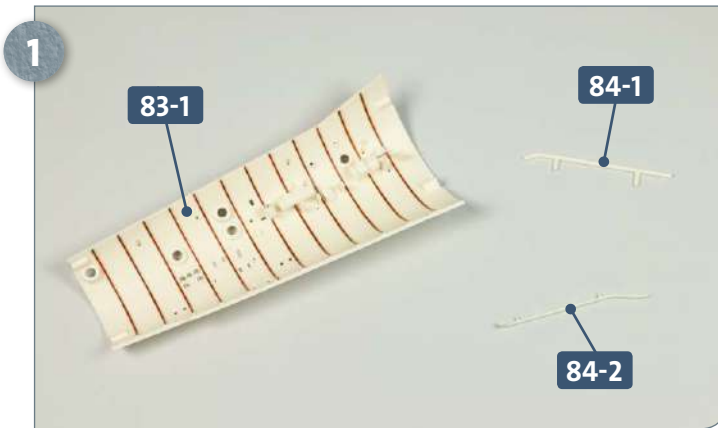

Place the electric motor room deckhead panel **83-1** and both lines **84-1** and **84-2** on your work surface.

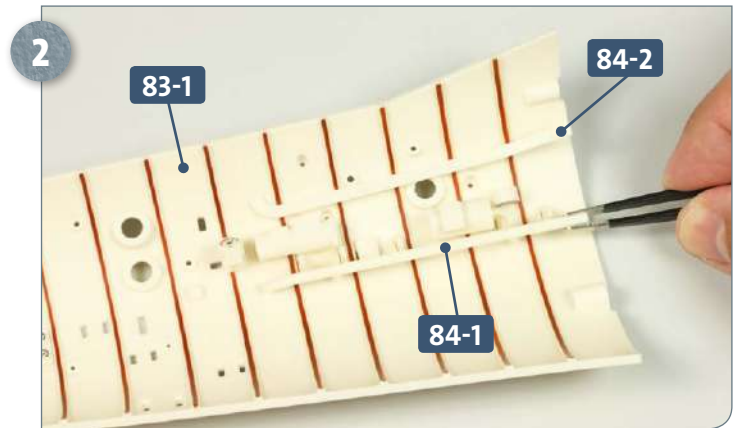

Apply some glue to the pegs on the back of the compressed air lines **84-1** and **84-2** and insert them into the corresponding holes in the deckhead panel **83-1**.

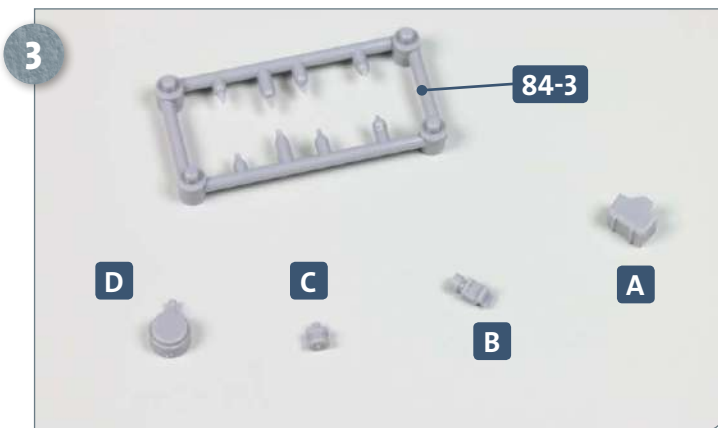

Take frame **84-3** and detach the four attachment pieces **A**, **B**, **C** and **D**.

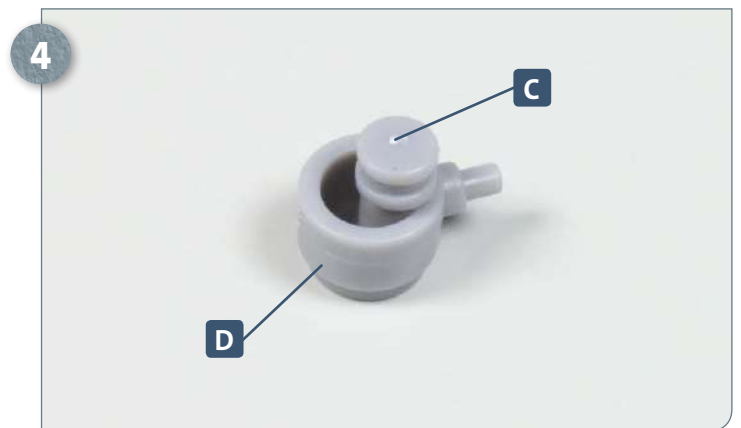

Apply some glue to the peg of part **C** and insert it into the hole of part **D**, as shown above.

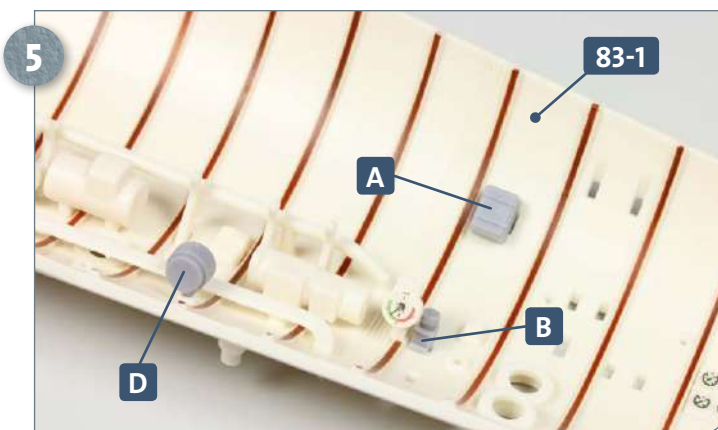

Glue attachments **A**, **B** and **D** to the deckhead panel **83-1**, as shown in the photo.

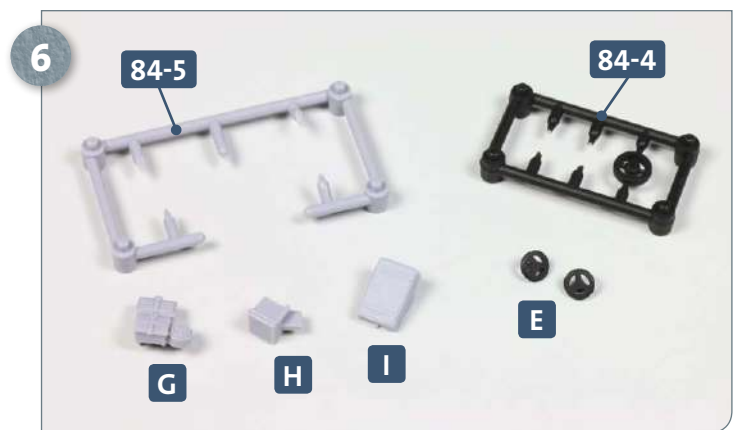

Take frames **84-4** and **84-5** and detach parts **G**, **H** and **I** and the two handwheels **E**.

Kit 84: Main rudder motor

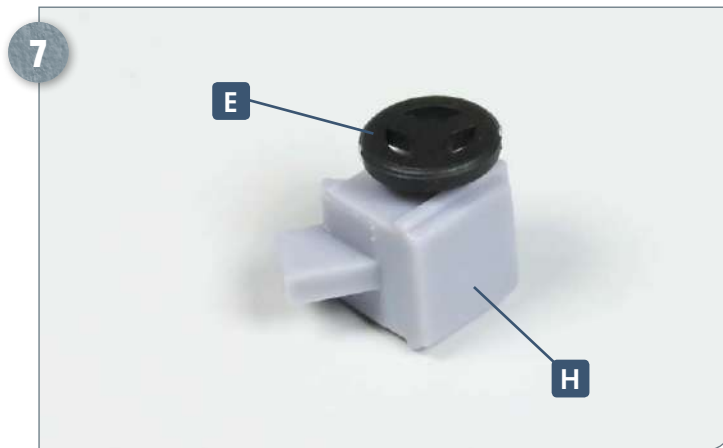

Apply some glue to the peg on one of the two handwheels **E** and insert it into the hole in attachment **H**.

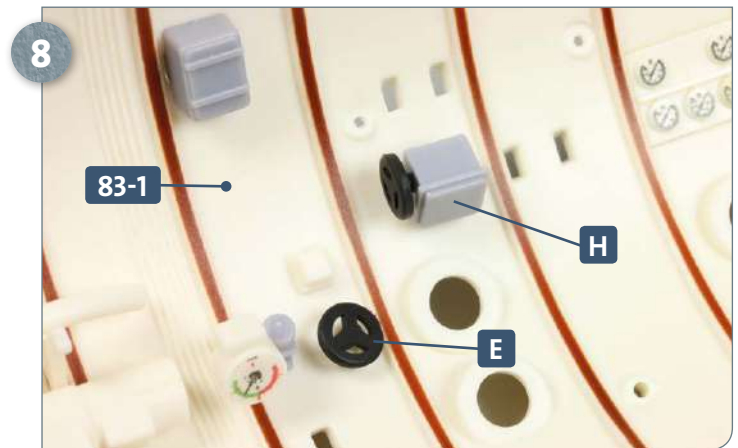

Glue attachment **H** and the second handwheel **E** to the deckhead panel **83-1**, as pictured.

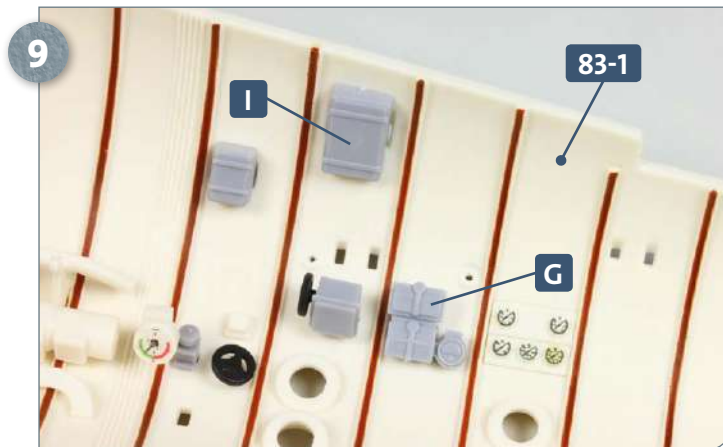

Apply glue to the two pegs on the back of attachment parts **G** and **I** and insert them into the corresponding slots in the deckhead panel **83-1**.

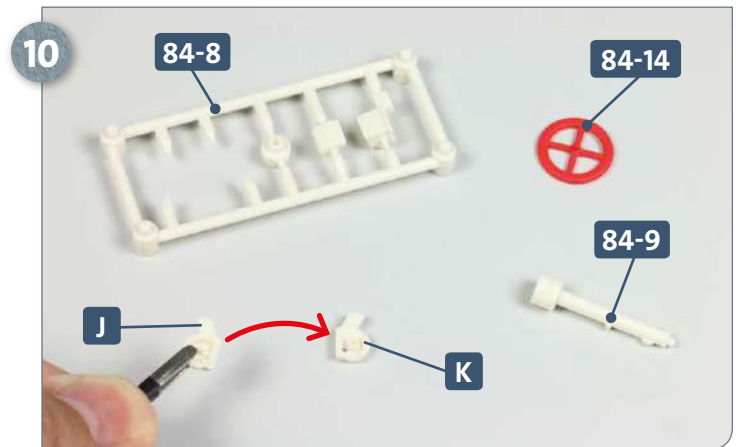

Take handwheel **84-14** and the emergency rudder column **84-9**. Separate the two attachments **J** and **K** from frame **84-8**. Apply glue to the peg of **J** and insert into the raised socket of **K**, as shown.

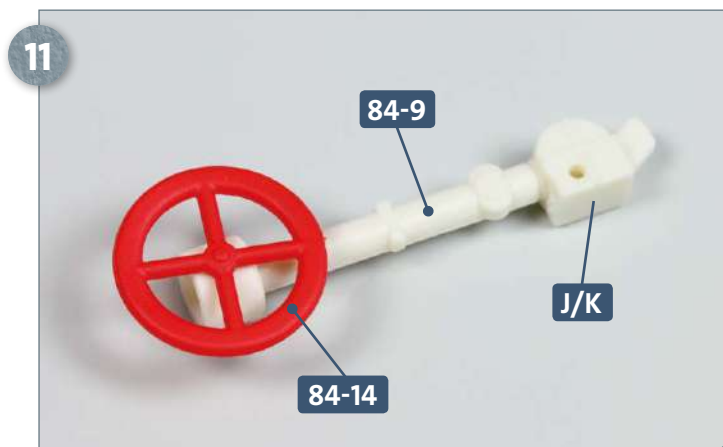

Apply a little glue to the peg of the handwheel **84-14** and fit it into the hole at the end of the column **84-9**, as shown. After applying glue to the peg at the other end of the column **84-9**, insert it into the slot in the attachment assembly **J/K**.



Apply some glue to the wider tab of attachment **J/K** and insert into the slot in deckhead panel **83-1**, as shown in the photograph.

Kit 84: Main rudder motor

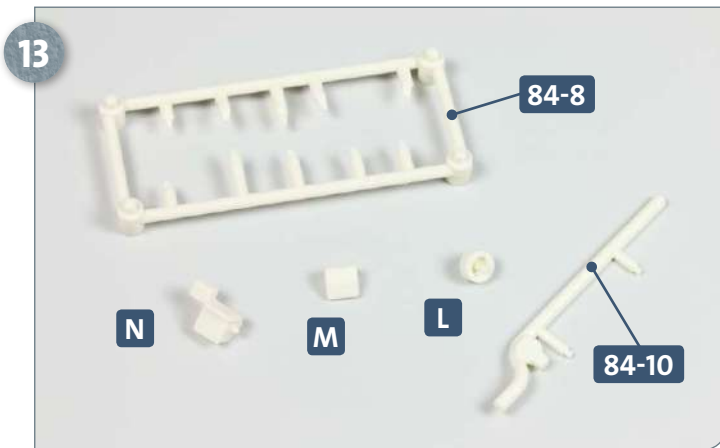

Take the compressed air line **84-10** and separate the remaining attachments, **L**, **M** and **N** from frame **84-8**.

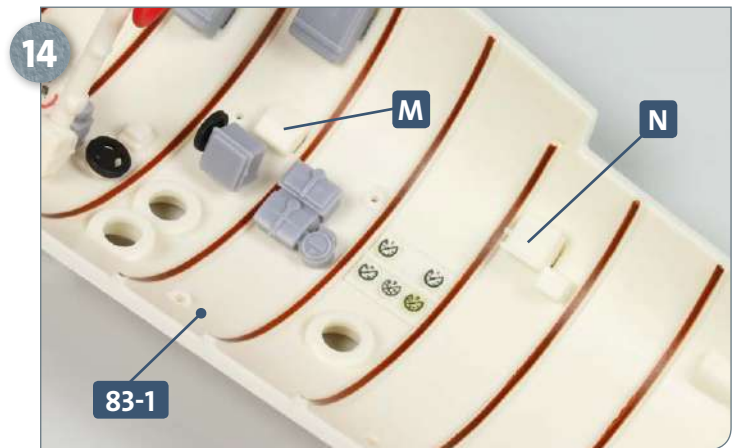

Apply glue to the two pegs on the back of the two attachments **M** and **N** and insert into the slots in the deckhead panel **83-1**.

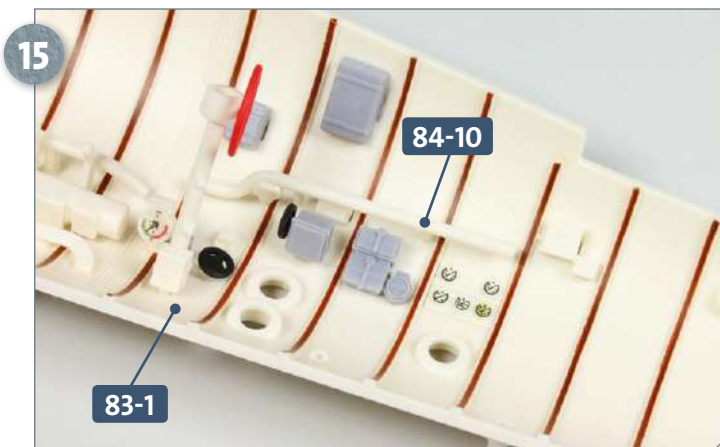

Apply some glue to the two pegs on the compressed air line **84-10** and insert into the holes in the deckhead panel **83-1**, as shown above.

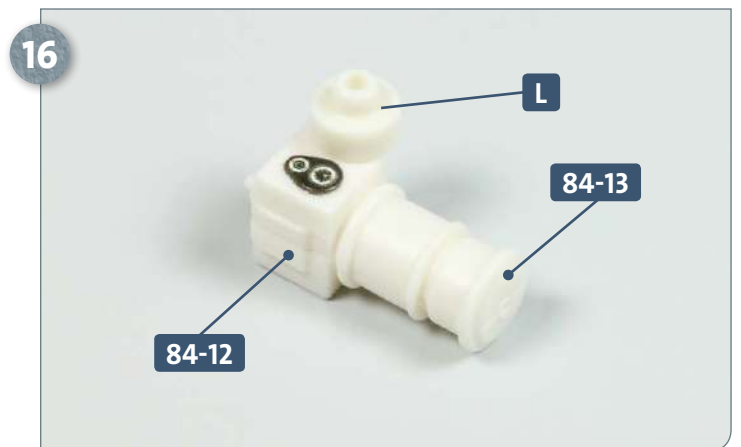

Take the two halves of the main rudder motor, **84-12** and **84-13**, and glue them together. Apply glue to the peg on attachment piece **L** and insert into the socket of part **84-13**.

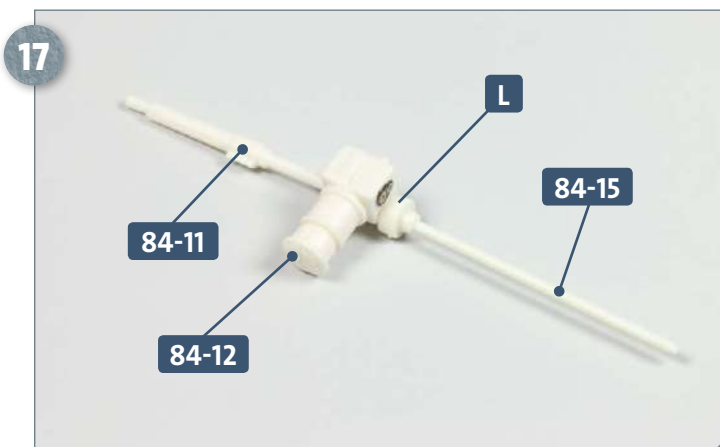

Glue the longer peg of drive shaft **84-15** into the hole of attachment **L**, and the wider end of drive shaft **84-11** into the hole of the main rudder motor **84-12**, as shown above.

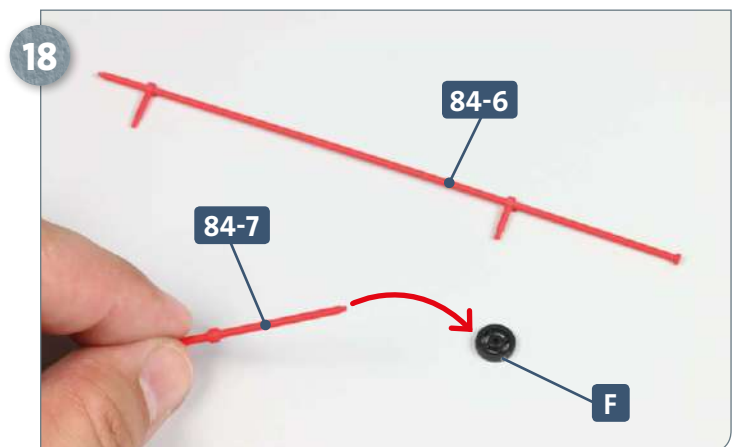

Separate the handwheel **F** from frame **84-4**. Apply some glue to the shorter peg of control rod **84-7** and insert into the hub of the handwheel, as pictured. Have ready control rod **84-6**.

Kit 84: Main rudder motor

19

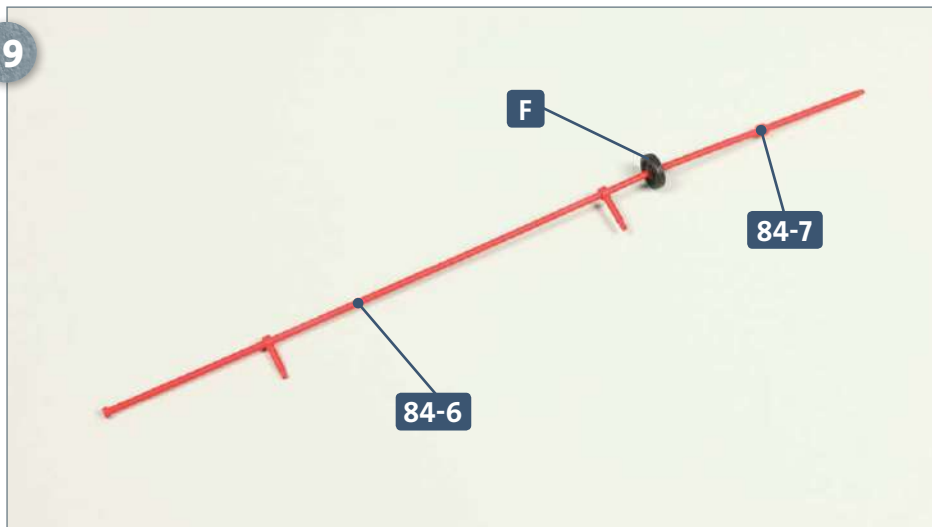

Once the control rod **84-7** has been attached to the handwheel **F**, glue the narrow end of control rod **84-6** to the other side of the handwheel, as pictured.

20

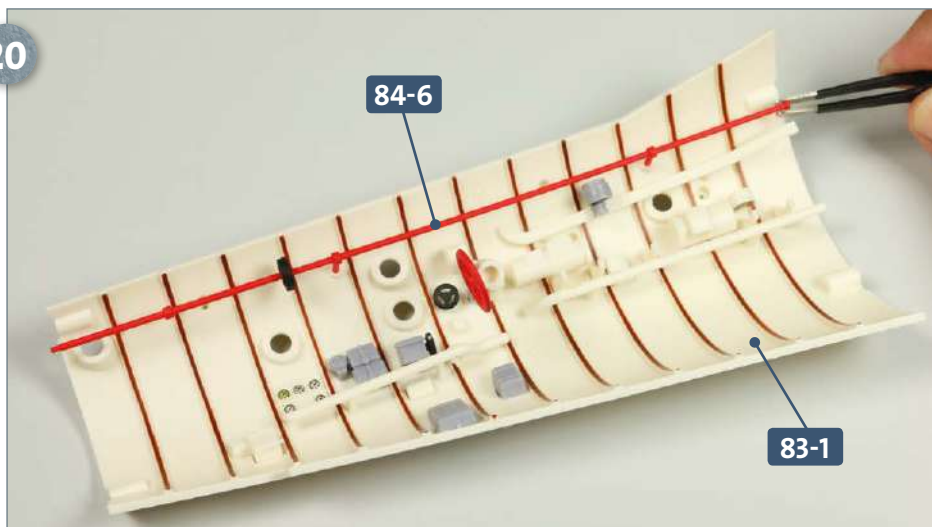

Apply some glue to the two pegs of control rod **84-6** and insert them into the holes in the deckhead panel **83-1**.

COMPLETED WORK

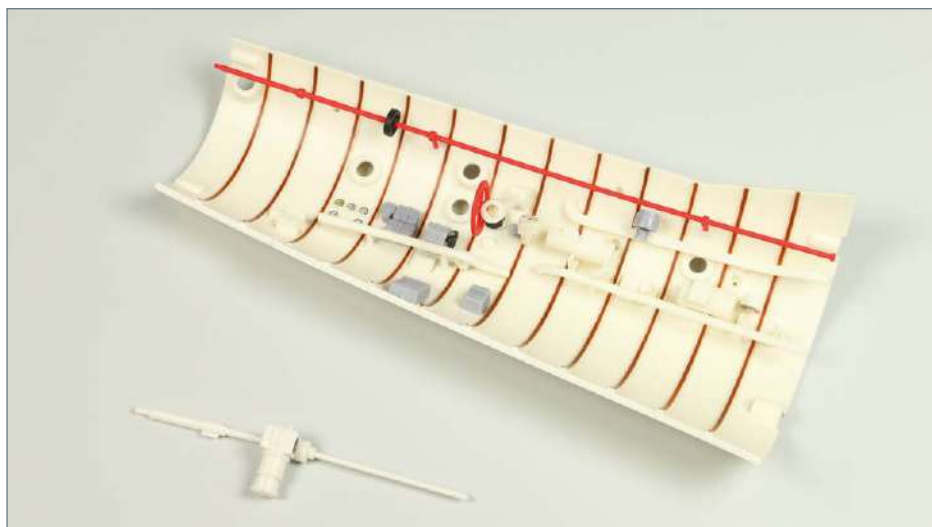

The deckhead of the electric motor room has now been further embellished with new components. The main rudder motor has been assembled and fitted with a control rod. This will be installed in the motor room in kit 91.