

U 96

U-BOAT

Pack 17

Assembly Instructions

Kit 65: The engine room (II)

Kit 66: The engine room (III)

Kit 67: The engine room (IV)

Kit 68: Engine room forward bulkhead



Hachette Partworks Ltd
4th Floor, Jordan House,
47 Brunswick Place, London, N1 6EB
www.U96-collection.com

© 2023/2024 Hachette Partworks Ltd.
ALL RIGHTS RESERVED
Not suitable for children under 14.

WARNING: All parts belong to a kit.
Collectors' item for adults. Not suitable for
children under 14. Some parts may have
sharp edges, please handle them with care.

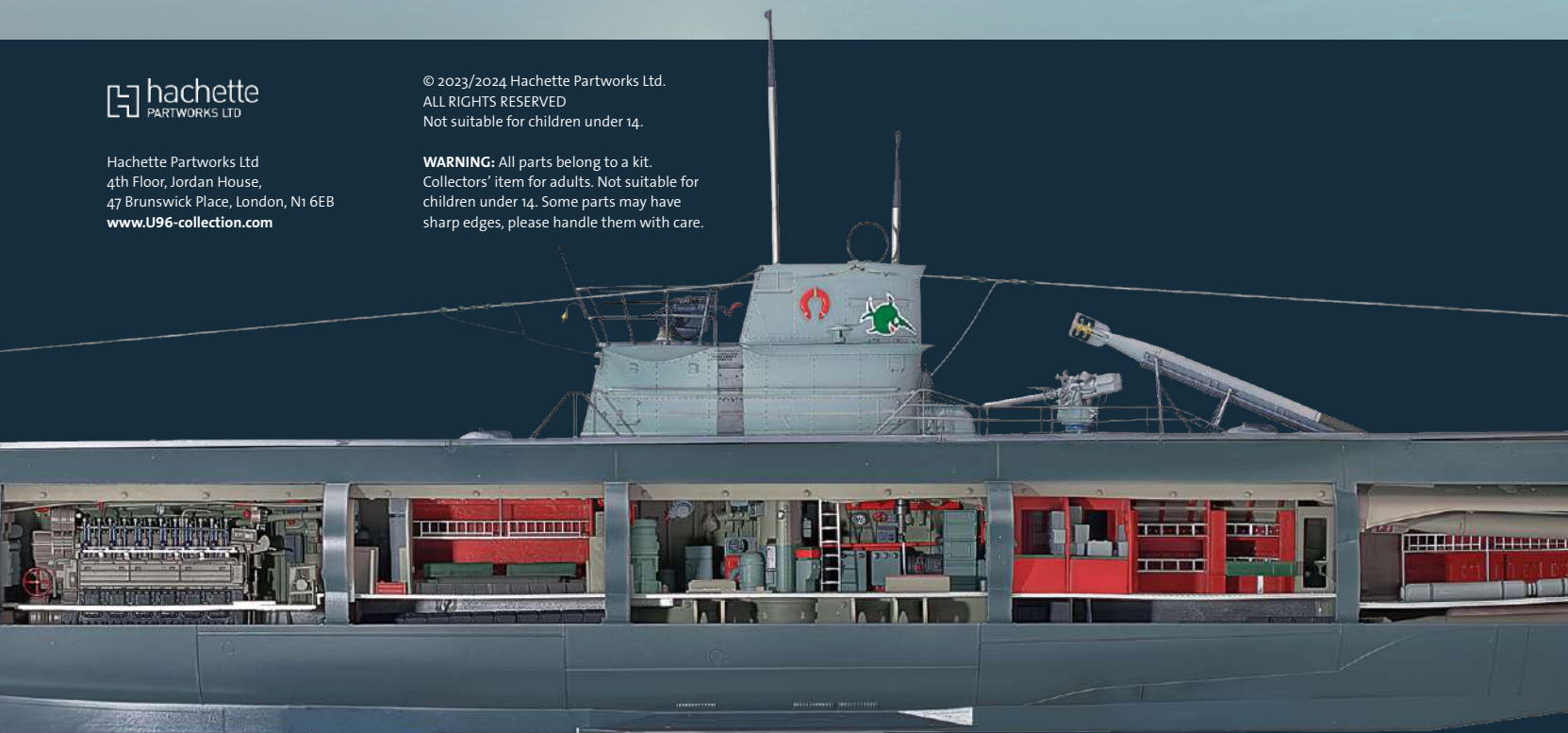

Kit 65: The engine room (II)

Work on the engine room continues in this kit with the assembly of the engine block. In addition, various attachments, couplings and a ventilation fan are built and attached to the engine block.

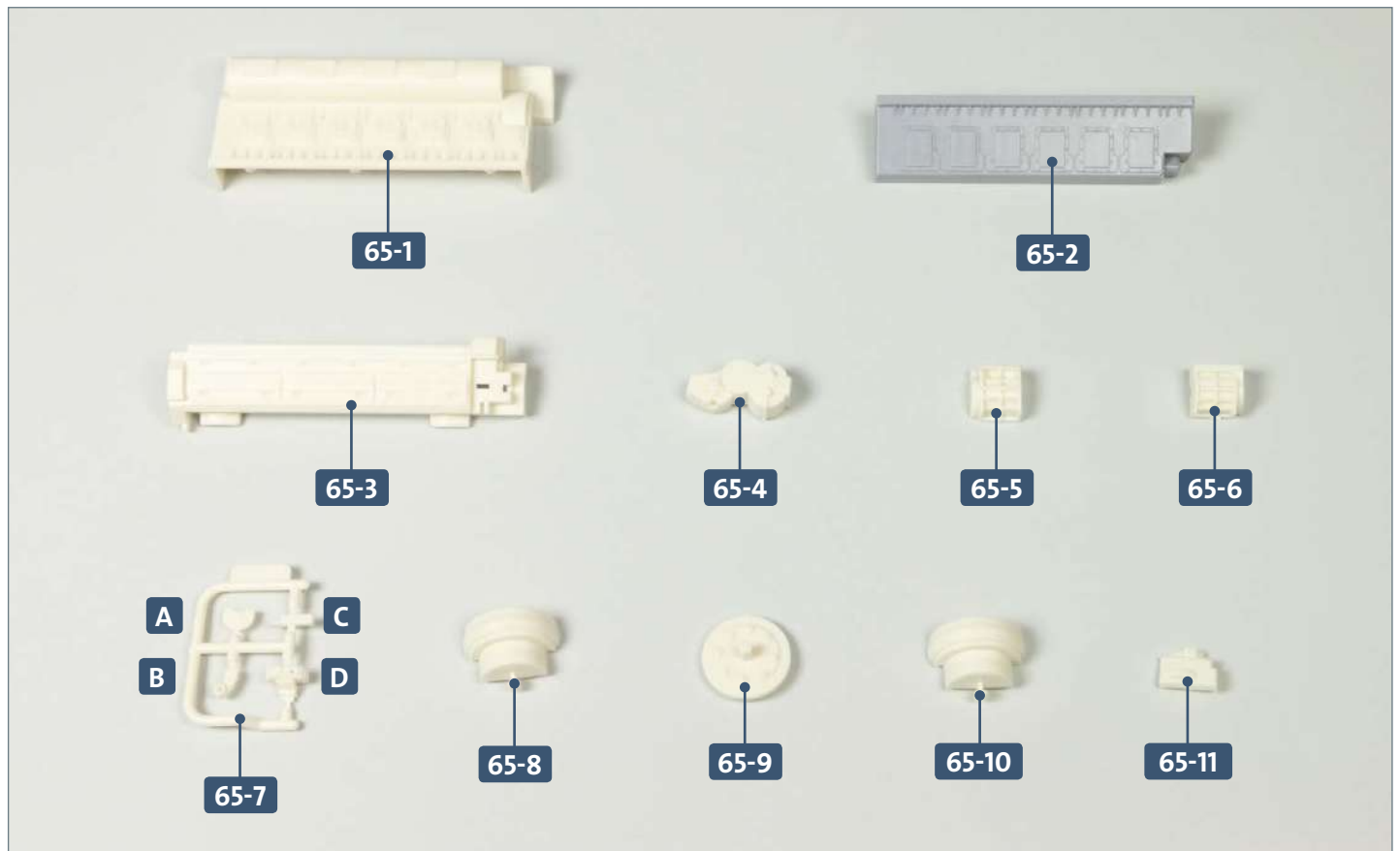

Parts reference list	
Part no.	Name
65-1	Engine block
65-2	Engine block
65-3	Engine block
65-4	Fan
65-5	Fan
65-6	Fan
65-7	Attachments
65-8	Engine coupling
65-9	Engine coupling
65-10	Engine coupling
65-11	Attachment

Kit 65: The engine room (II)

STAGE 1 → Diesel engine (continued)

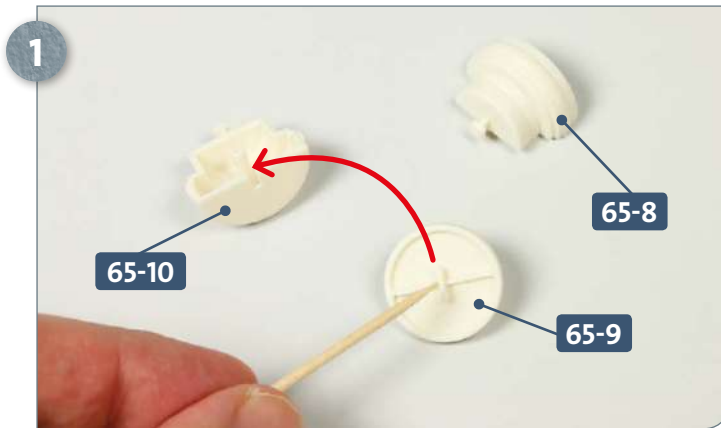

Place the three parts of the engine coupling, **65-8**, **65-9** and **65-10** on your work surface. Apply some glue to the peg of **65-9** and insert into the recess of **65-10**, as indicated by the arrow.

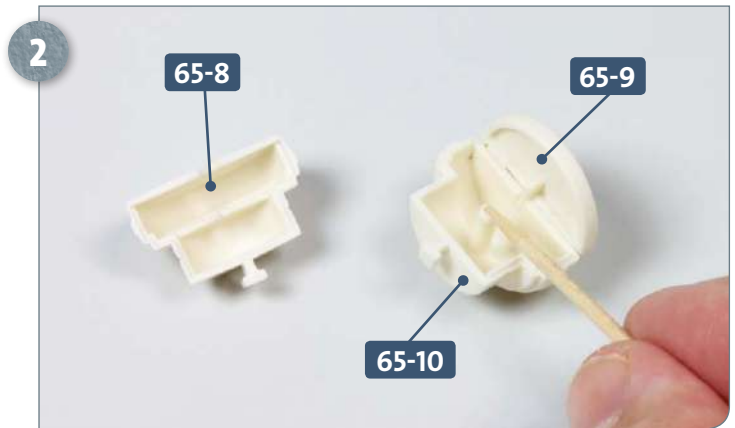

Once parts **65-9** and **65-10** are glued together, apply some glue to the raised socket on the inside of **65-10**, as shown in the photo.

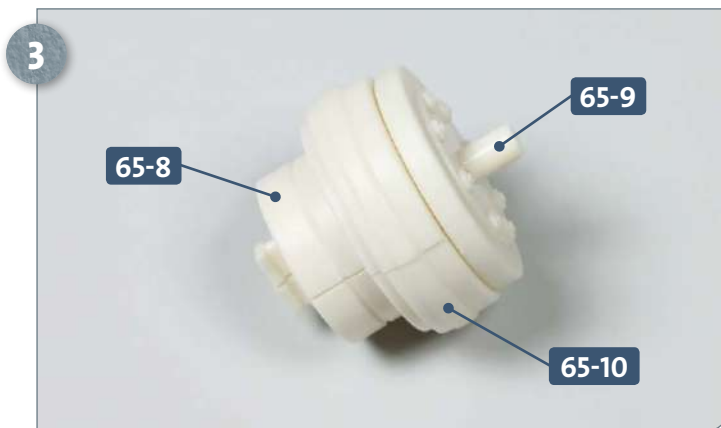

Finish the engine coupling by gluing **65-8** onto **65-10**, as pictured.

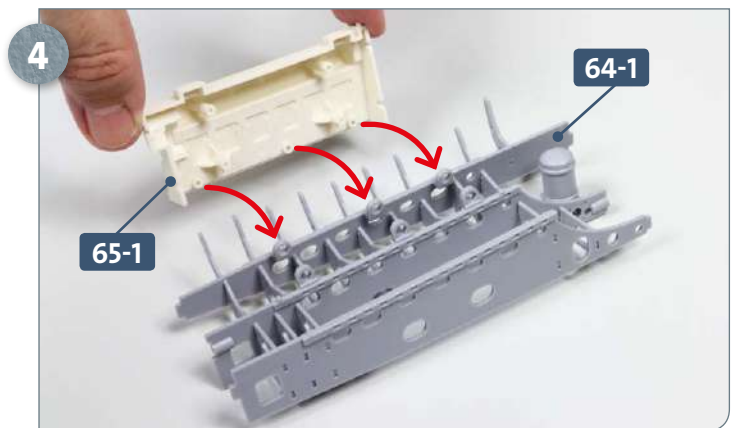

Have ready the engine foundation assembly you built in kit 64. Take engine block **65-1**, apply some glue to the three small pegs at the bottom, and fit them into the tabs on the strut **64-1**, as shown by the arrows.

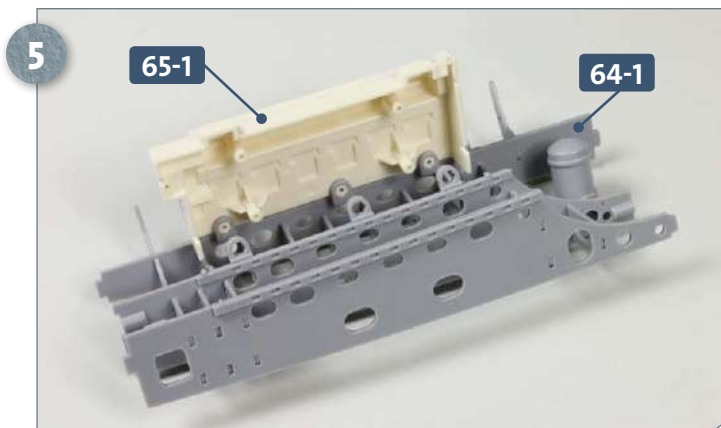

This photograph shows the engine block **65-1** correctly fitted onto the foundation strut **64-1**.

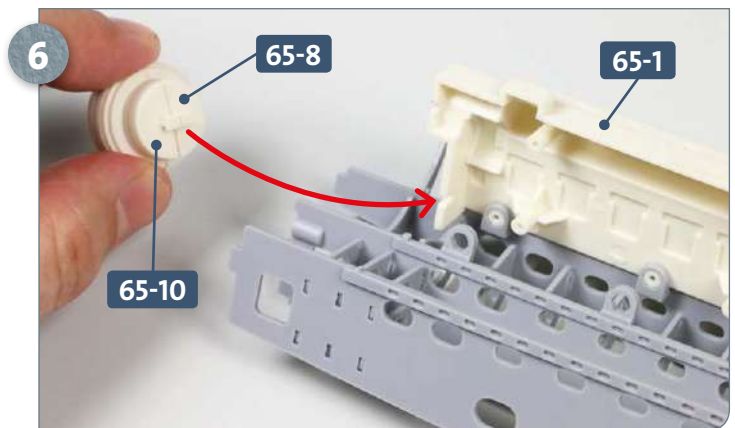

Take the assembled engine coupling and insert the long peg formed by **65-8** and **65-10** into the notch on the rear of the engine block **65-1**, as indicated by the arrow.

Kit 65: The engine room (II)

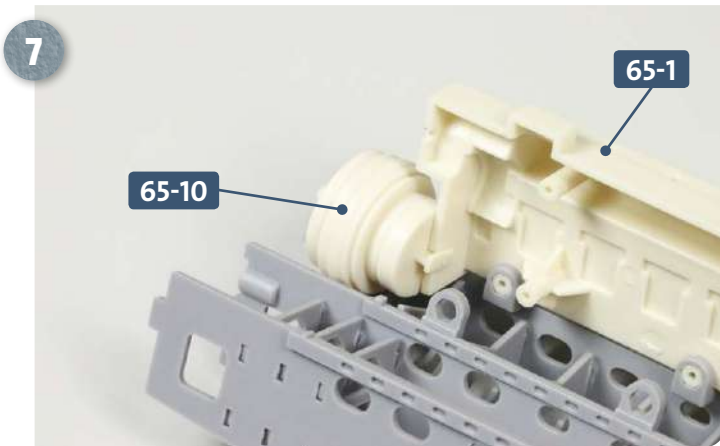

After test-fitting, as shown above, fix the coupling **65-10** to the engine block **65-1** with a little glue.

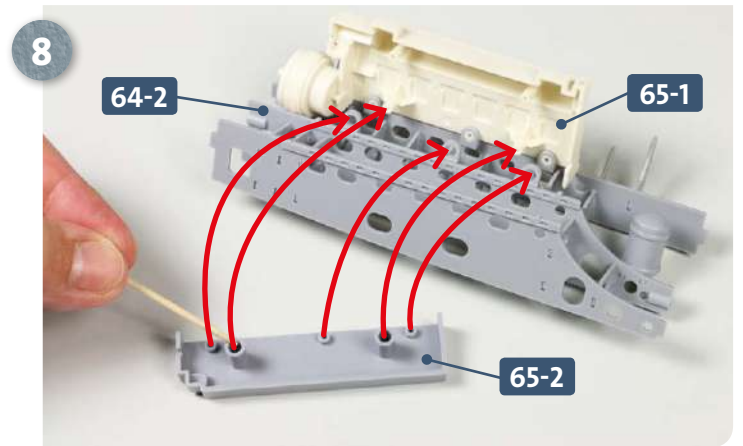

Take engine block **65-2** and apply glue inside the two raised sockets and to the three pegs along the edge. These glued pegs are then inserted into the holes in strut **64-2**. At the same time, the raised sockets on block **65-2** fit over the pegs on engine block **65-1**, as indicated by the arrows. Make sure that the pegs are fully inserted so that the parts fit together correctly.

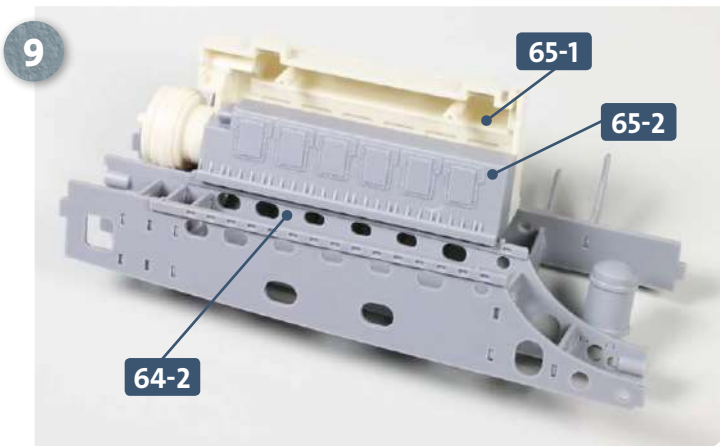

This photograph shows the engine block **65-2** attached to the other engine block **65-1** and foundation strut **64-2**.

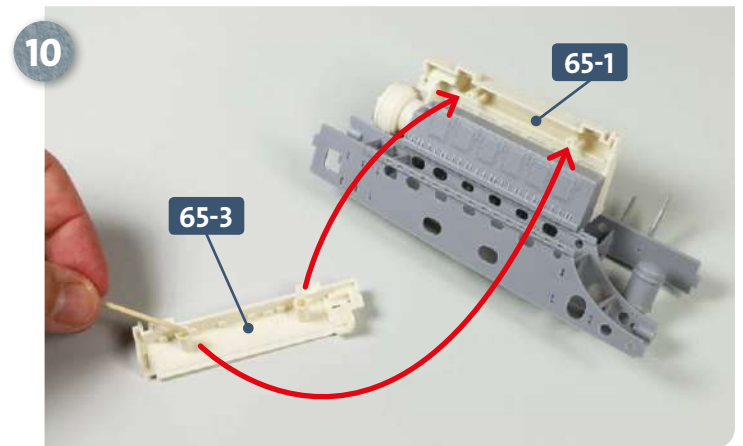

Place the engine block **65-3** on your work surface and apply some glue to the two raised sockets on the interior. These are pushed over the pegs on the inside of engine block **65-1**, as indicated by the two arrows.

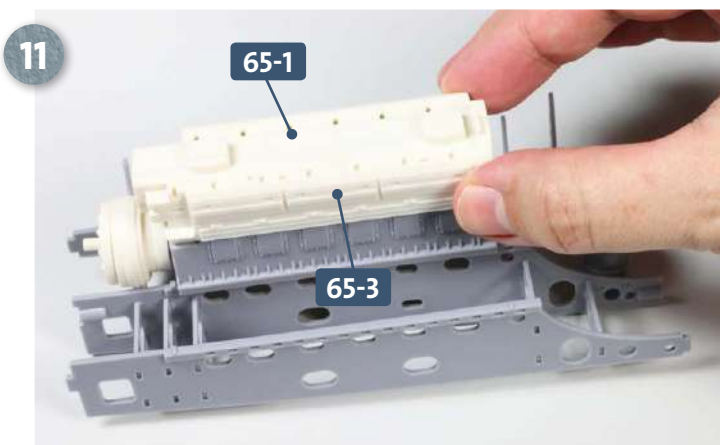

Press the two halves of the engine block, **65-3** and **65-1**, together, so that the join between them is seamless.

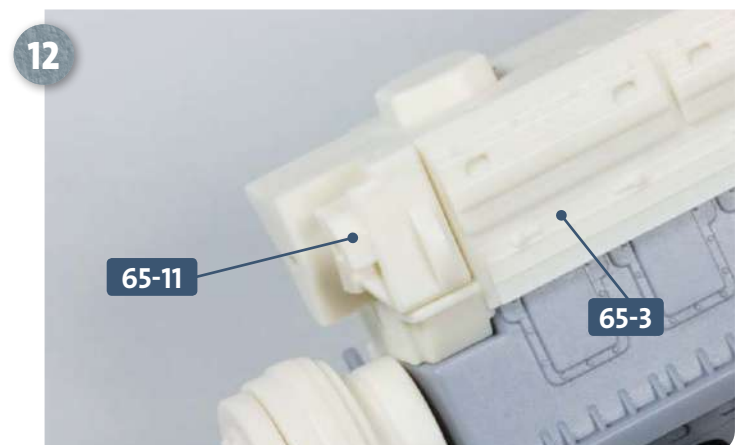

Take attachment **65-11**, apply some glue to the peg, and insert it into the slot at the back of engine block **65-3**. The photo shows the component in place.

Kit 65: The engine room (II)

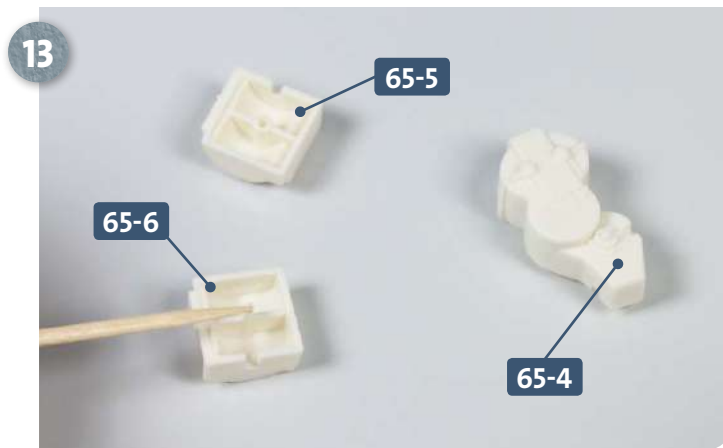

Have ready the three parts of the fan: **65-4**, **65-5** and **65-6**. Apply some glue to the peg on the inside of **65-6**.

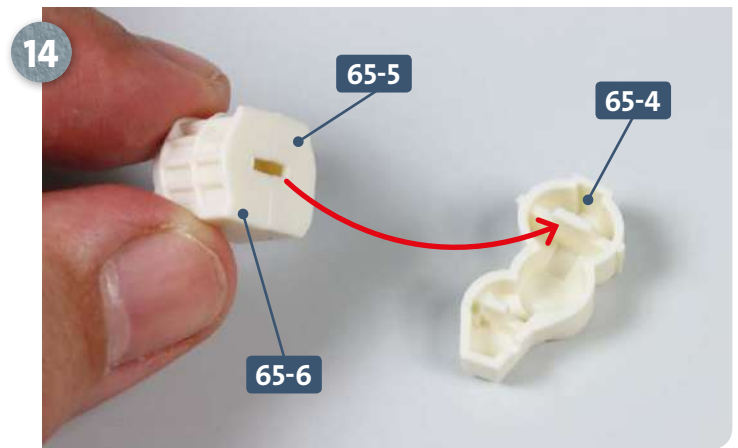

Fit parts **65-6** and **65-5** together. Apply some glue to the slot formed by the two parts and fit it onto the tab on the back of **65-4**, as pictured above.

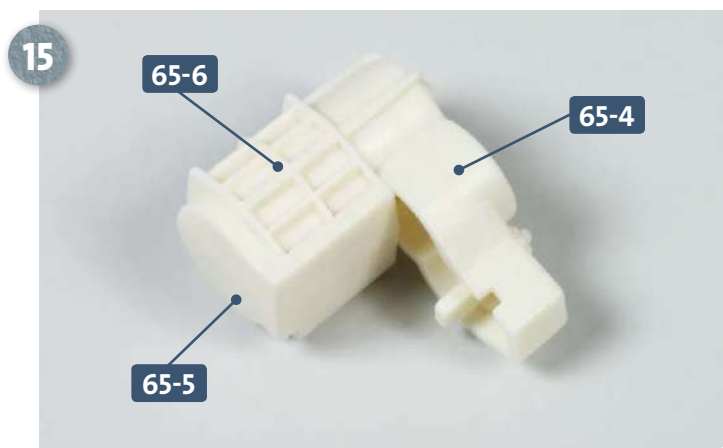

This photograph shows parts **65-5/65-6** joined to **65-4** to complete the fan assembly.

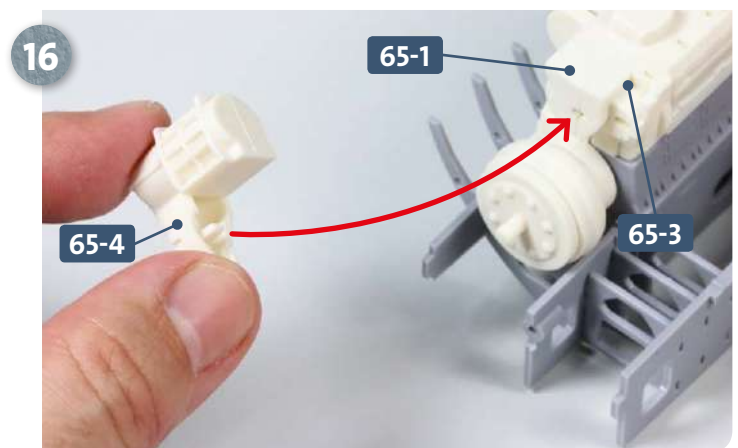

Turn the fan assembly over and apply some glue to the tab at the bottom of part **65-4**. This is then inserted into the engine block mount **65-1/65-3**, as indicated.

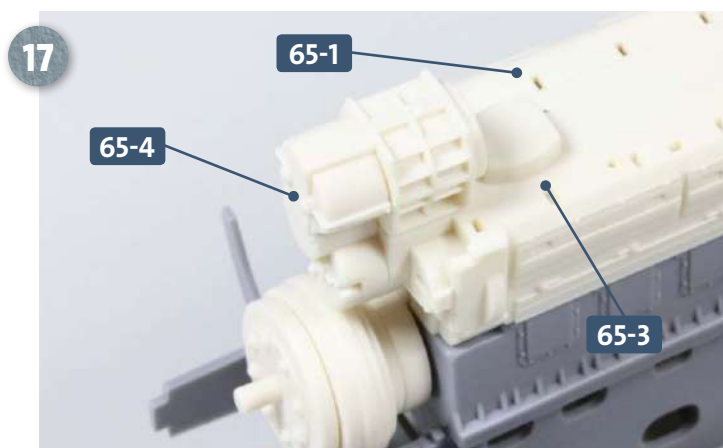

This photograph shows the fan assembly fitted in place.

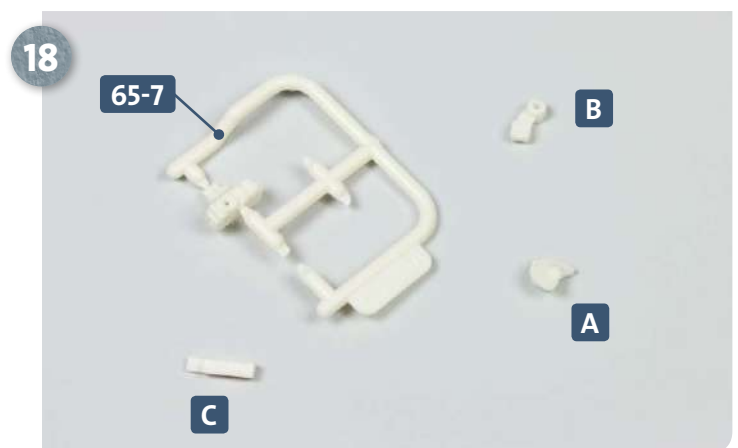

Take frame **65-7** and detach parts **A**, **B** and **C**.

Kit 65: The engine room (II)

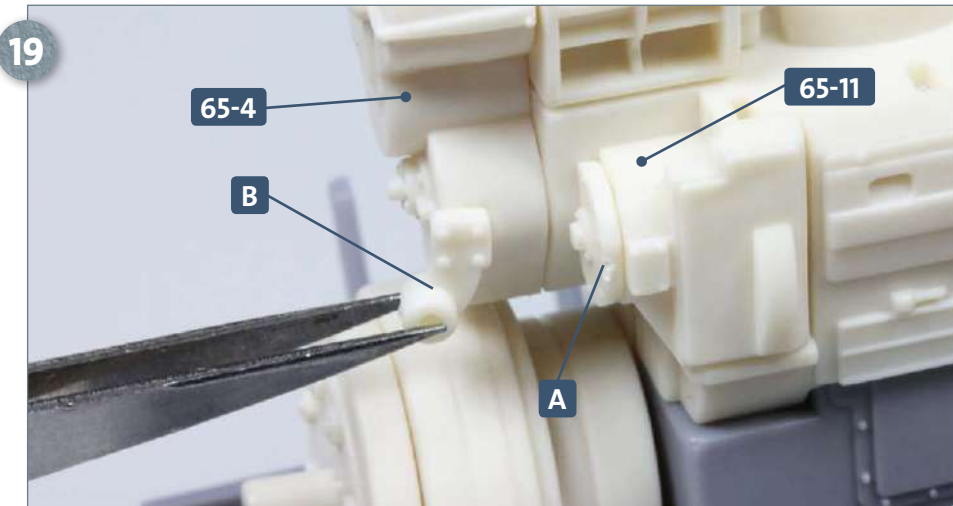

Apply some glue to the peg on the back of part **A** and attach it to the recess at the back of attachment **65-11**. Part **B** is glued into the recess in the fan assembly **65-4**, as pictured.

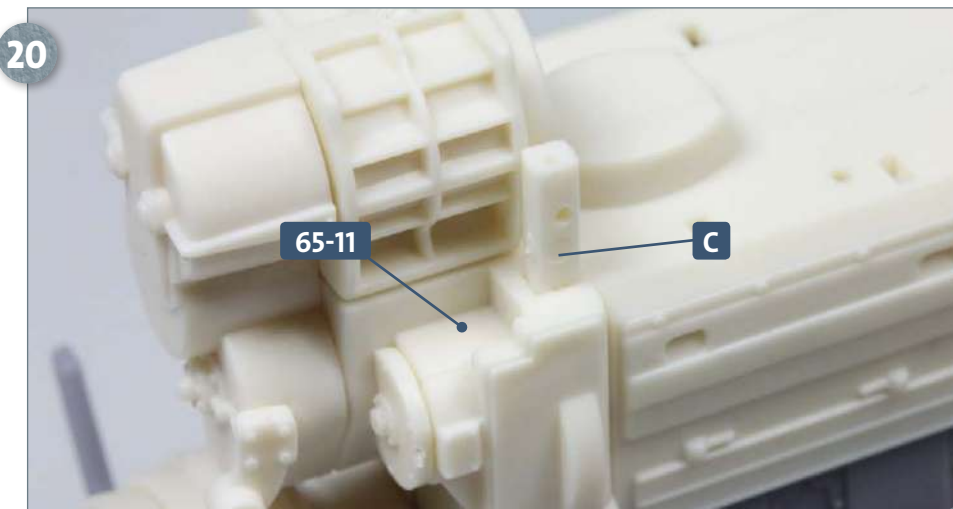

After carefully noting the orientation, apply some glue to part **C** and glue it into the recess at the top of attachment **65-11**.

COMPLETED WORK

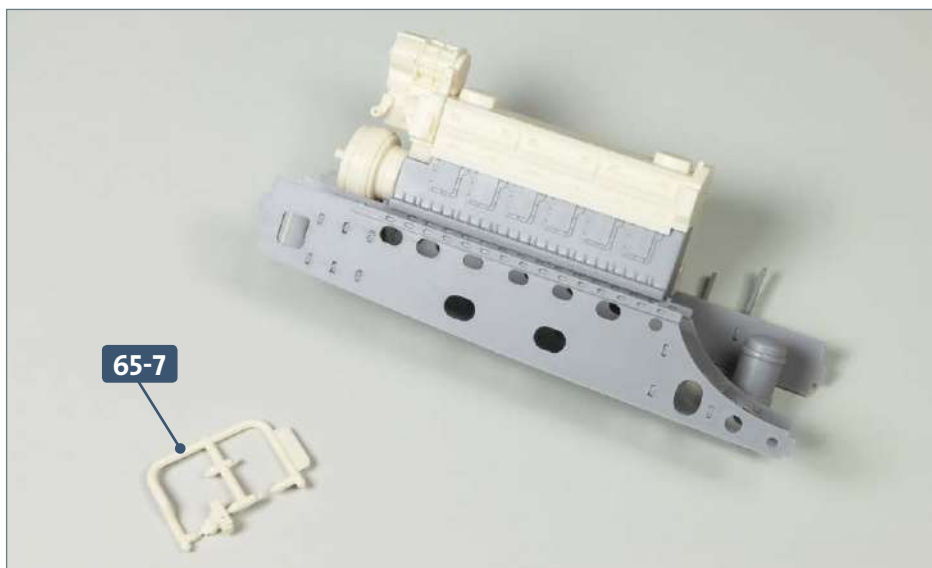

Work on the diesel engine has progressed with further parts of the engine block mounted on the foundation struts. Keep frame **65-7** somewhere safe for use in a future kit.

Kit 66: The engine room (III)

In this kit, the engine is equipped with additional components: the control station, a cylinder cover including the fuel oil line, indicator taps, cooling water lines and an attachment.

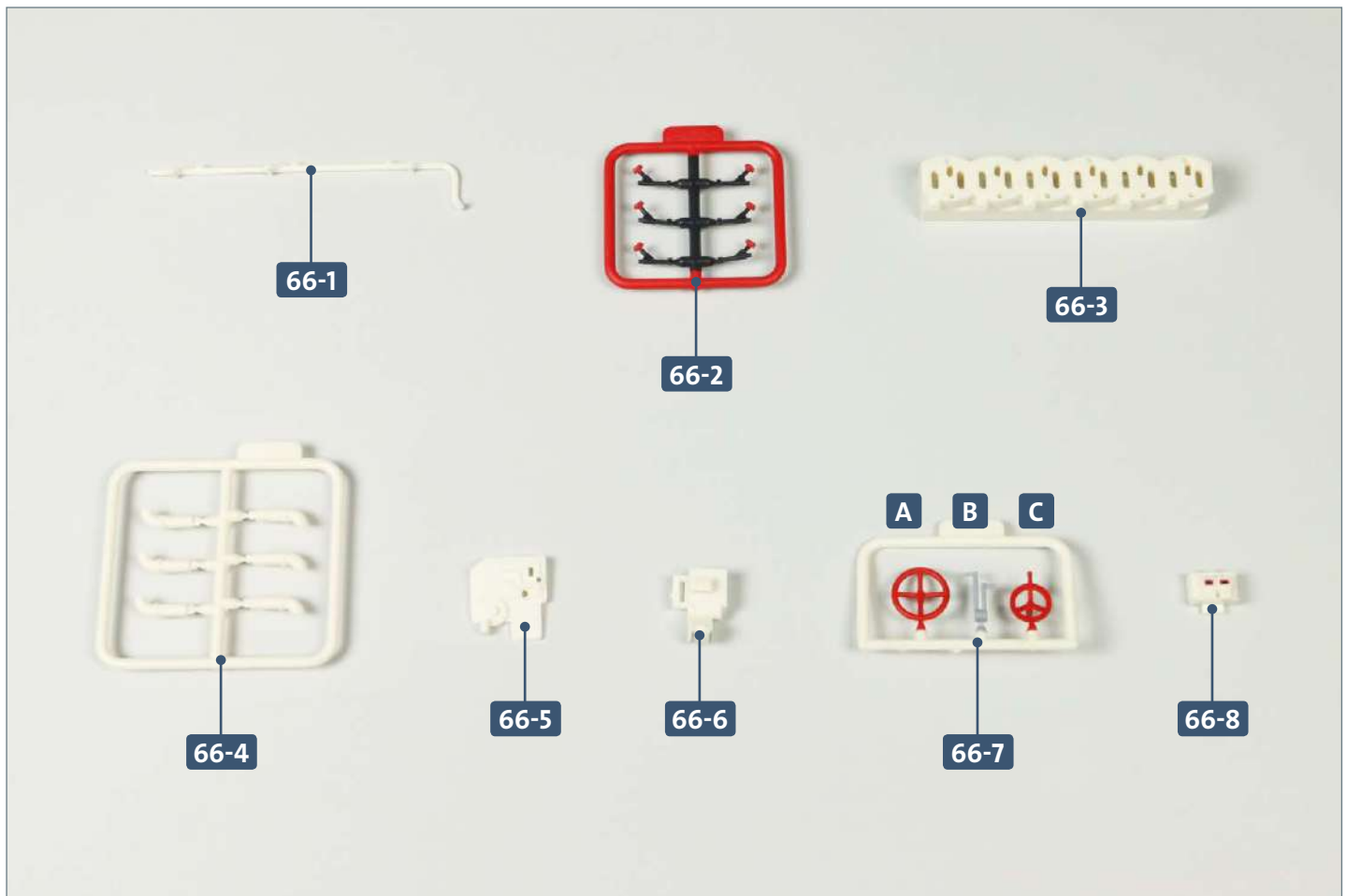

Parts reference list

Part no.	Name
66-1	Fuel oil line
66-2	Indicator taps
66-3	Cylinder cover
66-4	Cooling water lines
66-5	Attachment
66-6	Control station
66-7	Engine clutch handwheel, starting lever and starting air valve
66-8	Oil pump

STAGE 1 → Diesel engine (continued)

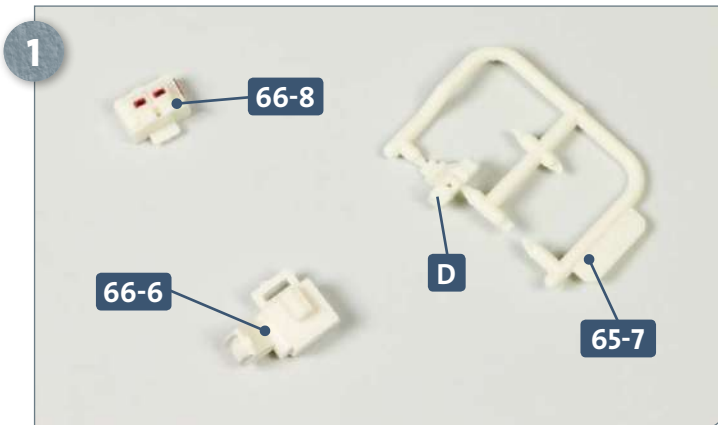

Place the control station **66-6**, oil pump **66-8** and frame **65-7** from kit 65 on your work surface. Remove part **D** from the frame.

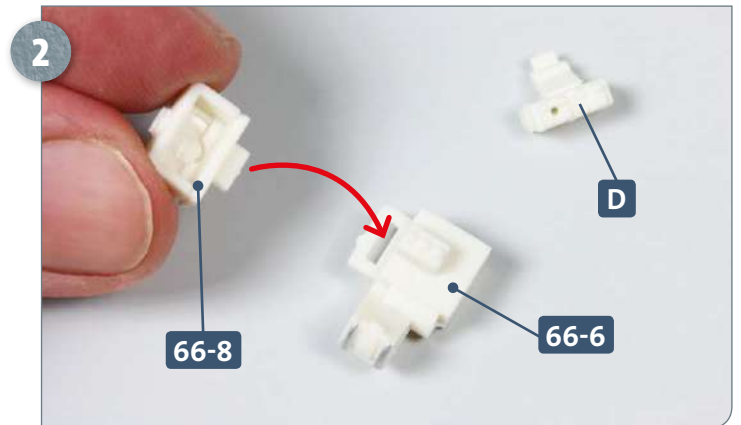

Apply some glue to the peg on the underside of the oil pump **66-8** and glue it into the recess in the control station **66-6**, as indicated by the arrow.

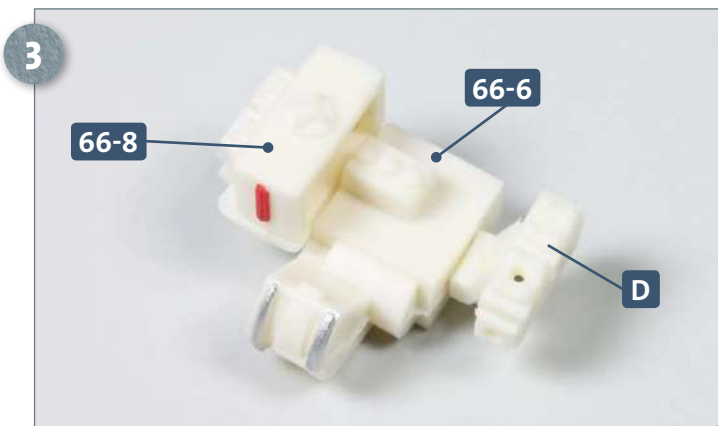

The photograph shows the oil pump **66-8** attached to the control station **66-6**. Part **D** needs to be attached to the opposite end: add some glue to the tab and insert into the corresponding slot.

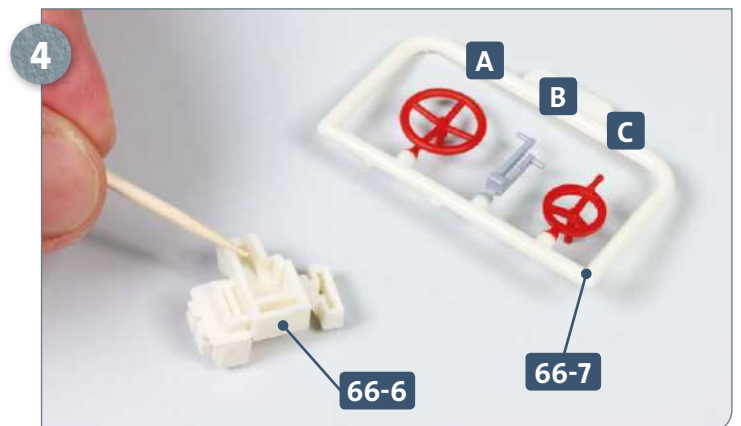

Turn the control station **66-6** over and apply some glue to the back, as shown. Lay out frame **66-7** and detach the starting lever **B** from it.

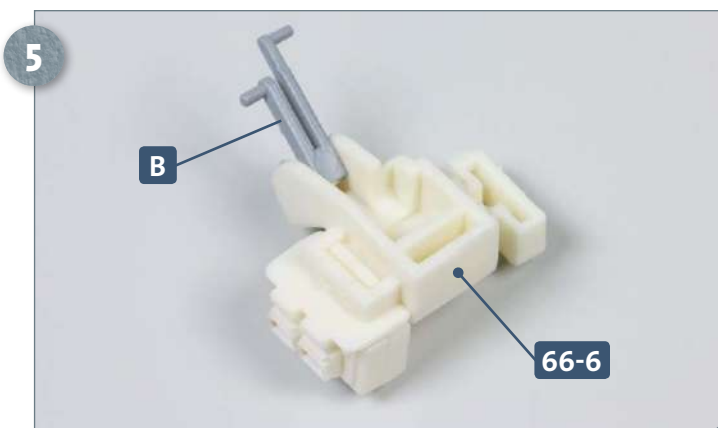

Attach lever **B** to the interior of the control station **66-6**, as pictured above.

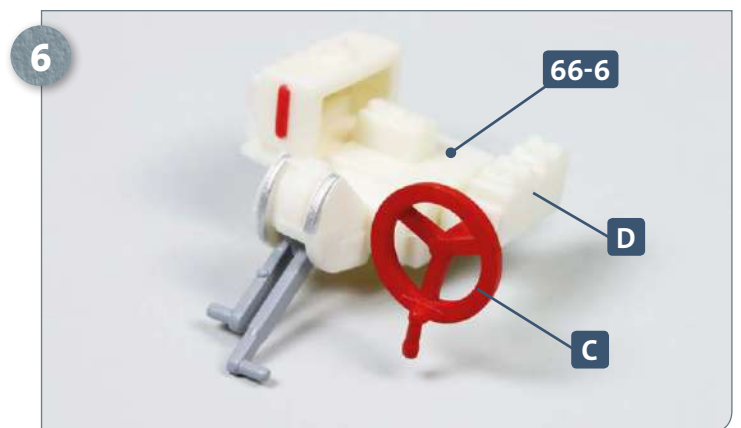

Detach the starting air valve handwheel **C** from frame **66-7**. Apply some glue to the back of the peg and glue it into the hole in attachment part **D**, as shown above.

Kit 66: The engine room (III)

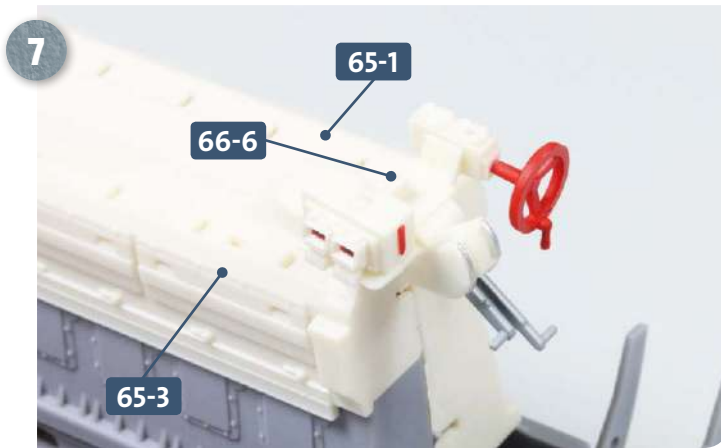

Apply some glue to the peg at the front end of engine block assembly **65-1/65-3** and attach the control station **66-6** to it.

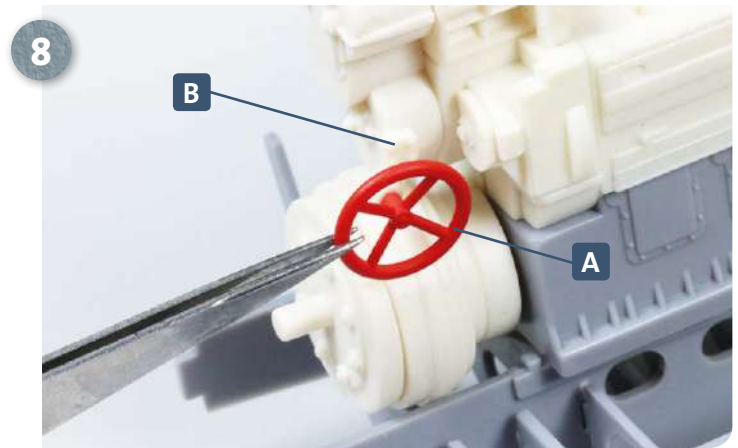

Now turn your attention to the aft end of the engine. Detach handwheel **A** from frame **66-7** and glue it into the hole of attachment **B** (frame **65-7**, included with the previous kit), as pictured above.

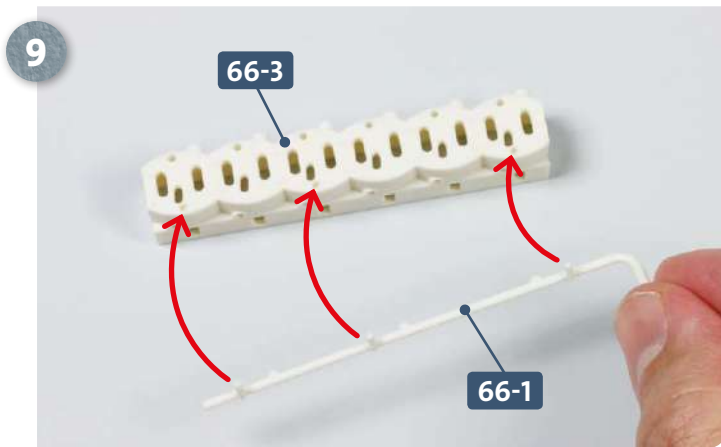

Place the cylinder cover **66-3** on your work surface. Apply some glue to the three pegs of the fuel oil line **66-1** and insert these into the recesses on the top of the cylinder cover, as indicated by the three arrows.

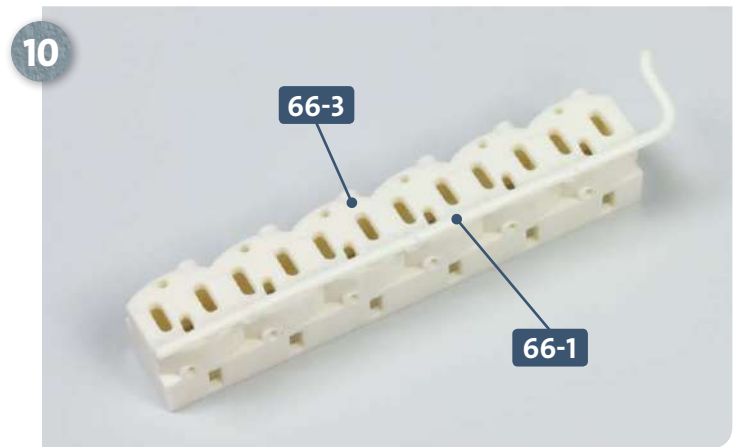

This photograph shows the fuel oil line **66-1** attached to the cylinder cover **66-3**

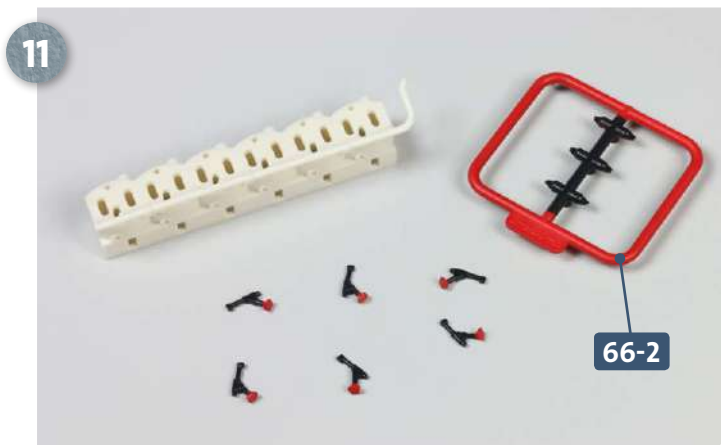

Take frame **66-2** and carefully detach the six identical black and red indicator taps.

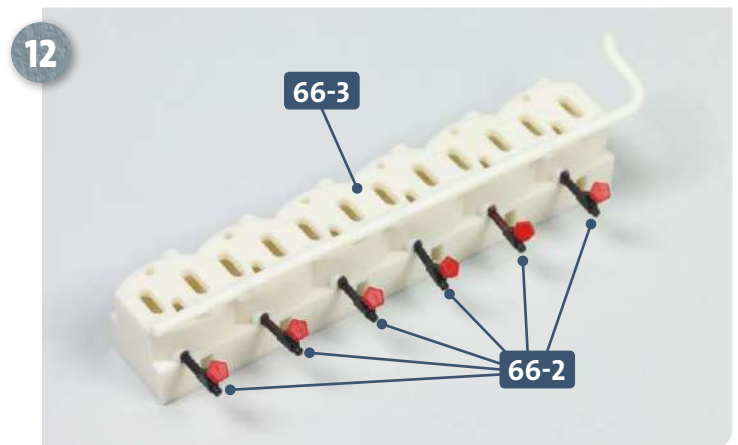

Glue the six indicator taps **66-2** into the recesses at the front of the cylinder cover **66-3**.

Kit 66: The engine room (III)

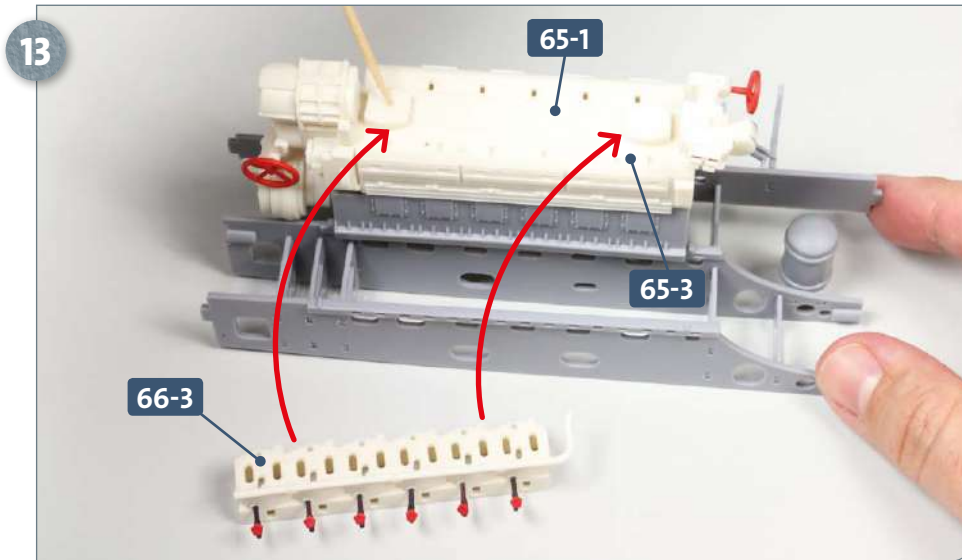

Apply some glue to the two large protrusions at the top of the engine block **65-1/65-3**. Take the cylinder cover **66-3** and fit it on top of the engine, as indicated by the two arrows.

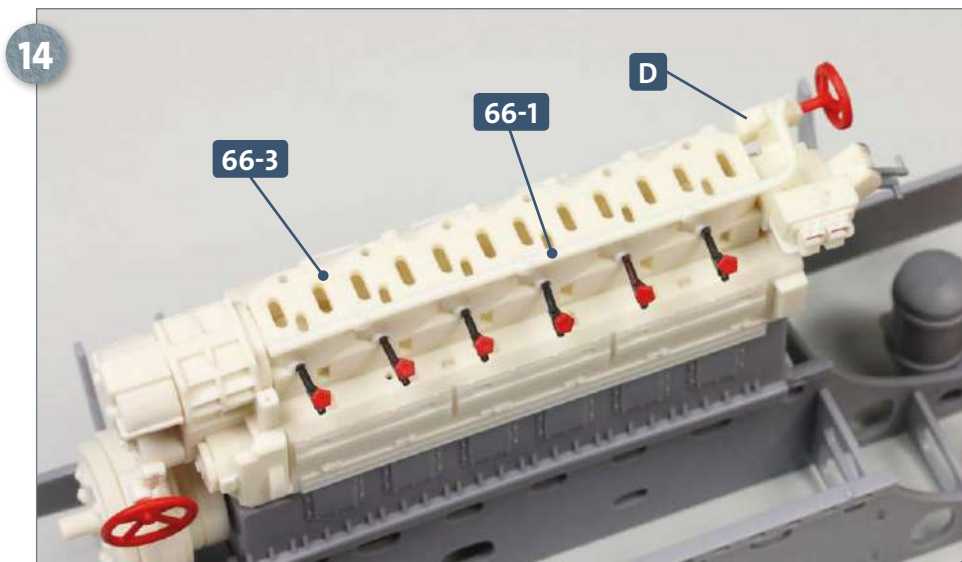

The cylinder cover **66-3** is glued to the engine block. Next, insert the peg at the front end of the fuel oil line **66-1** into the hole at the top of attachment **D**, as shown in the photo.

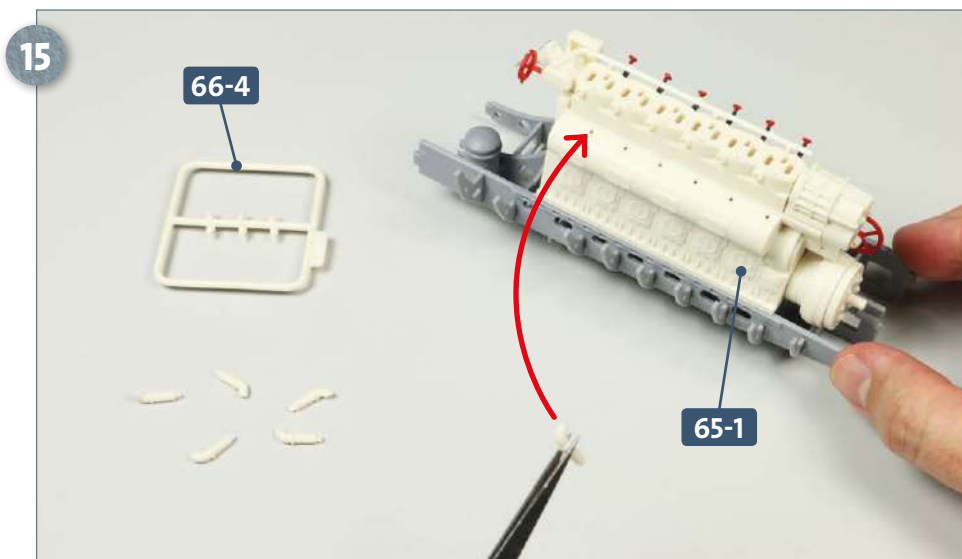

After turning the engine assembly around, take frame **66-4** and carefully detach the six cooling water pipes. Apply some glue to the peg of the first line and insert it into the hole on the top of the engine block **65-1**, as indicated by the arrow.

Kit 66: The engine room (III)

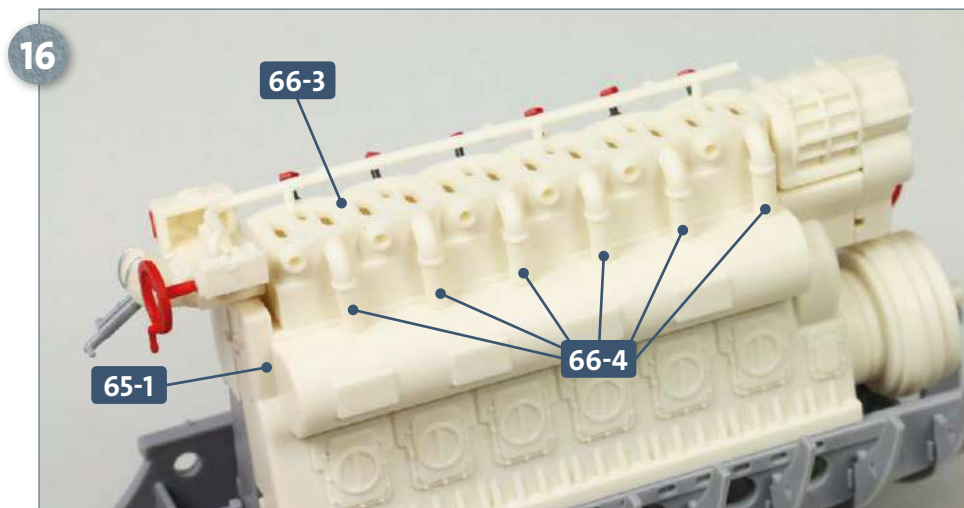

Repeat the process with the five remaining cooling lines **66-4**, gluing the ends to the top of the engine block **65-1** as pictured. The curved upper ends of the six lines about the cylinder cover **66-3**.

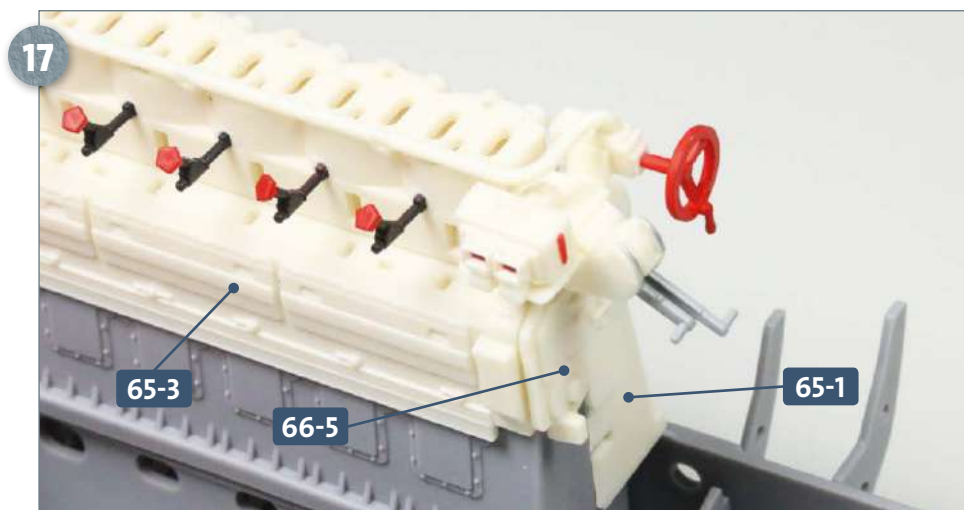

Finally, glue attachment **65-5** to the front of the engine block assembly **65-1/65-3**: apply a little glue to the peg on the attachment **65-5** and insert into the corresponding slot on the engine.

COMPLETED WORK

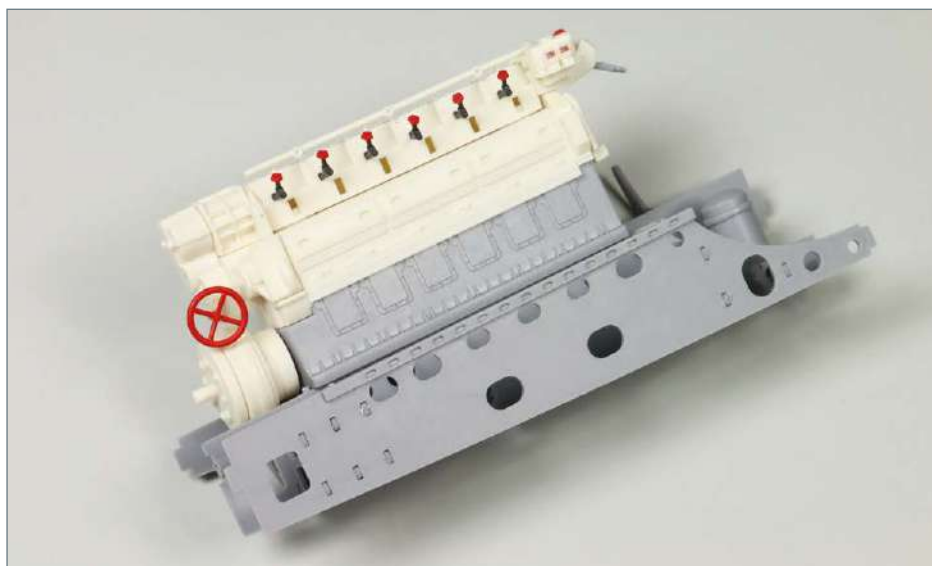

The engine is taking shape with the cylinder cover and various other details now attached to the assembly.

Kit 67: The engine room (IV)

Work on the engine room continues in this kit, concentrating on the cylinder cover. Various fuel oil pumps, rocker arms and valve levers are attached, and the exhaust manifold and control linkage installed.

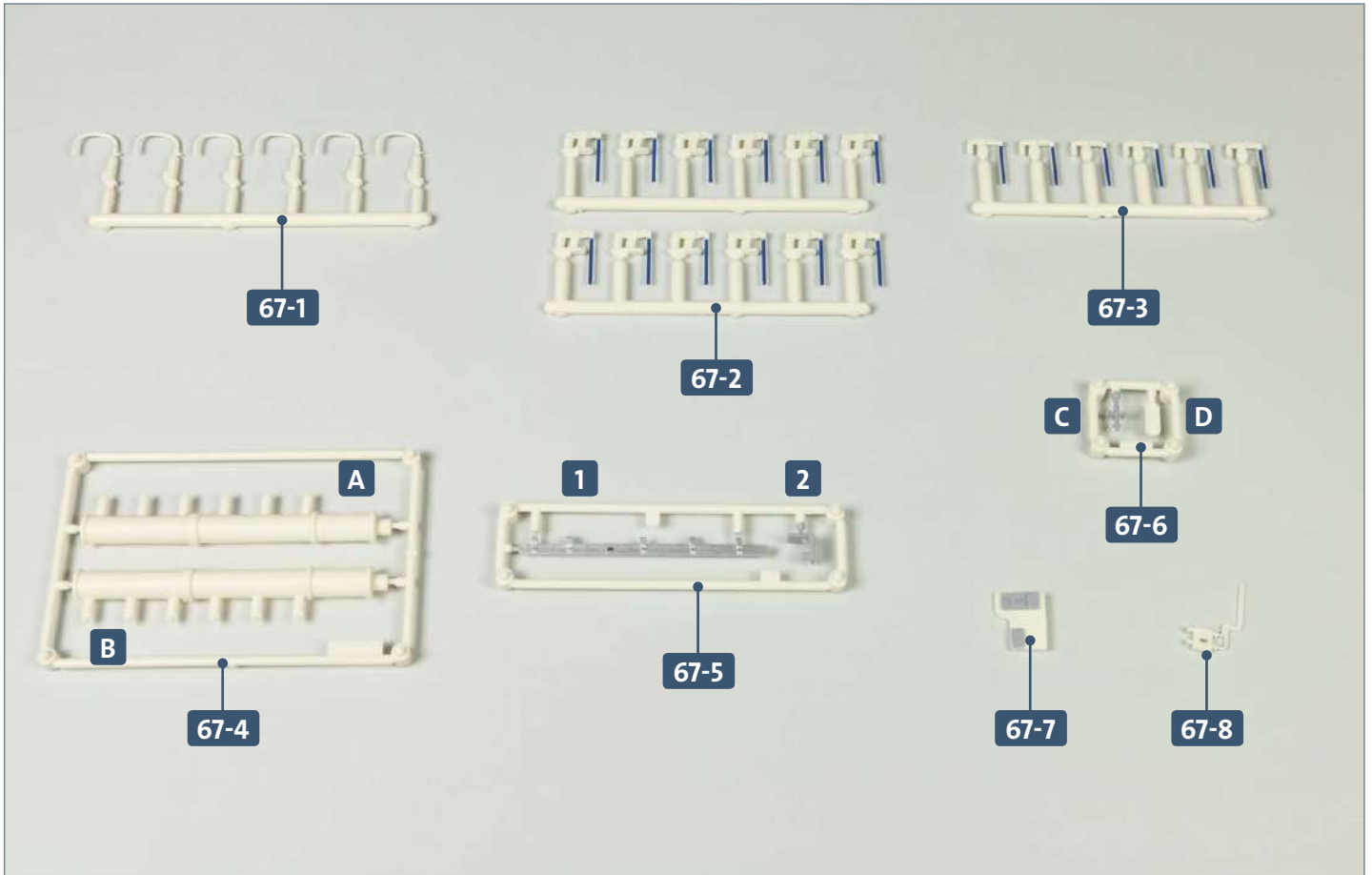

Parts reference list		
Part no.	Name	
67-1	Fuel oil pumps	
67-2	Rocker arms and valve levers for intake and exhaust valves (12)	
67-3	Rocker arms and valve levers for intake and exhaust valves (6)	
67-4	Two halves of exhaust manifold	
67-5	Control linkage and attachment	
67-6	Attachment and revolution counter	
67-7	Attachment	
67-8	Attachment	

Note: If parts in a frame are not identical, they will be numbered so they can be distinguished from one another. For example, part 1 of frame 67-5 is designated 67-5-1 in the instructions. Any components not numbered in this way are differentiated by marked letters.

Kit 67: The engine room (IV)

STAGE 1 → Diesel engine (continued)

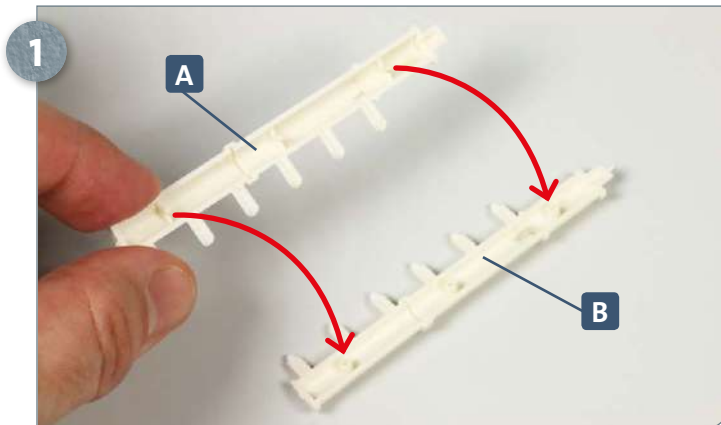

Remove the two halves of the exhaust manifold, **A** and **B**, from frame **67-4**. Apply some glue to the pegs of **A** and fit these into the corresponding sockets of **B**.

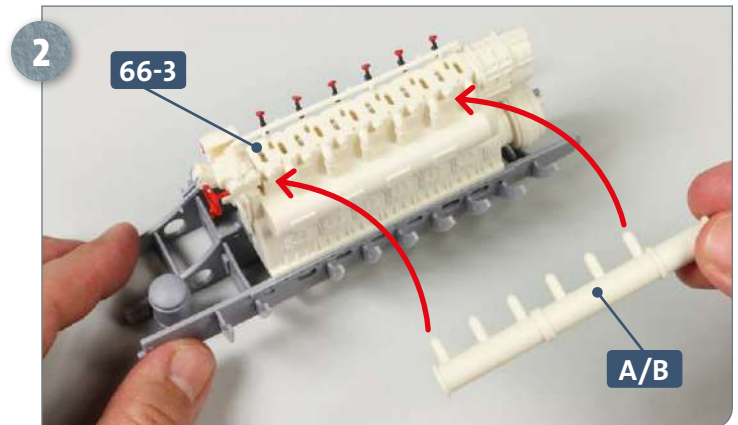

Apply some glue to the six branches of the exhaust manifold **A/B** and attach these to the receiving slots on the cylinder cover **66-3**, as indicated by the arrows.

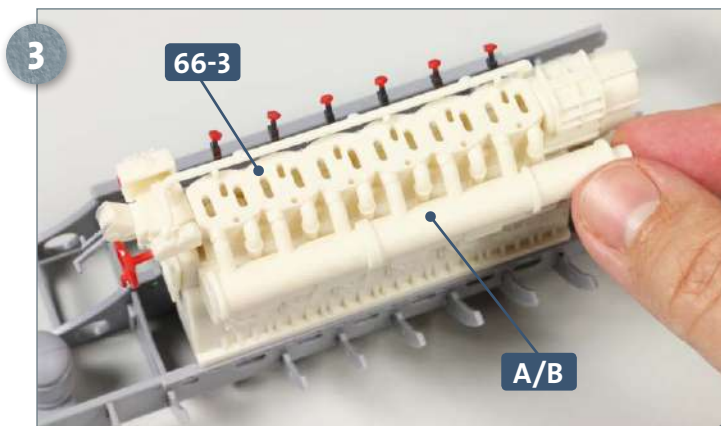

When attaching the exhaust manifold **A/B** to the cylinder cover **66-3**, make sure it is fully seated by carefully pressing the ends of the branches into their sockets as far as they go.

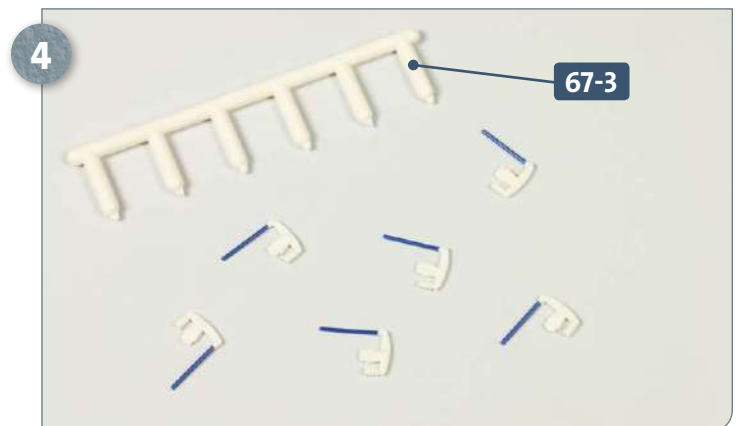

Take time to study the two types of rocker arms; there are 12 of one type on the frames **67-2** and six of another on frame **67-3**. Remove the six rocker arms and valve levers from frame **67-3**. Smooth out any trace of the attachment points.

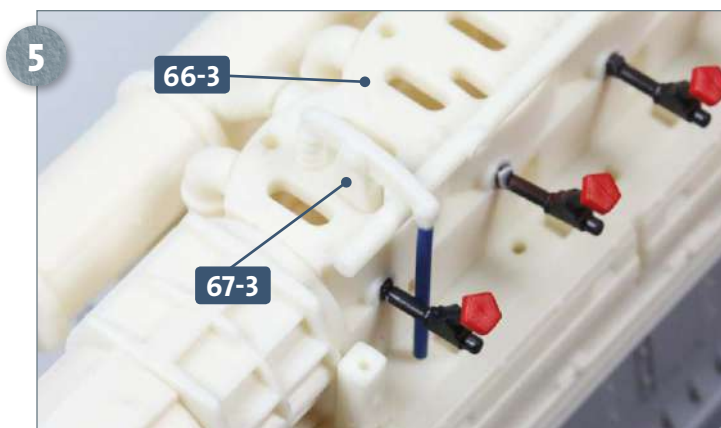

Take the first piece **67-3**, apply some glue to the wide peg on the underside, and insert into the slot in the cylinder cover **66-3**, as pictured above.

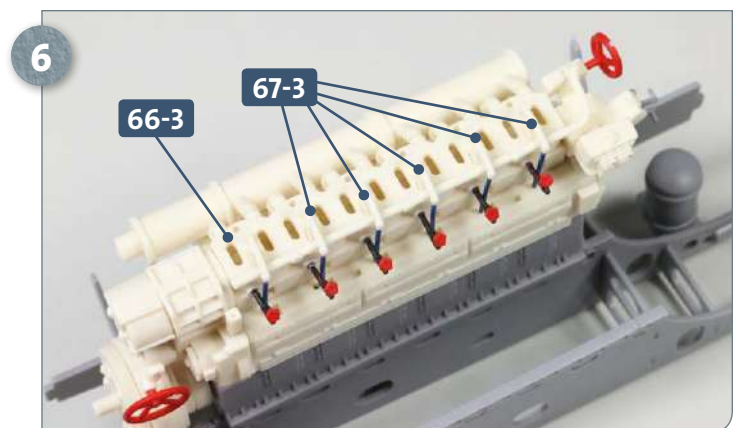

Repeat the process with the five remaining rocker arms and valve levers **67-3**. These are glued into the adjacent slots in the cylinder cover **66-3**.

Kit 67: The engine room (IV)



Separate all 12 rocker arms and valve levers from frames **67-2**. Again, remove any trace of the attachment points if necessary.

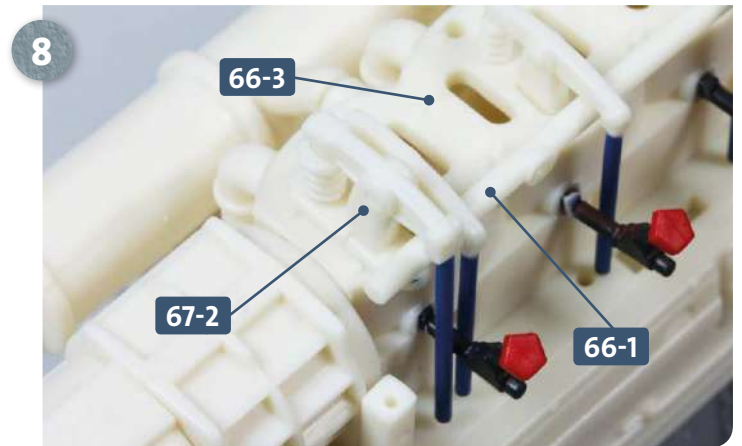

Take the first piece **67-2**, apply some glue to the wide peg on the underside, and insert into the elongated slot in the cylinder cover **66-3**. If needed, carefully bend the blue end of **67-2** slightly outwards so that it fits around the fuel oil line **66-1**.

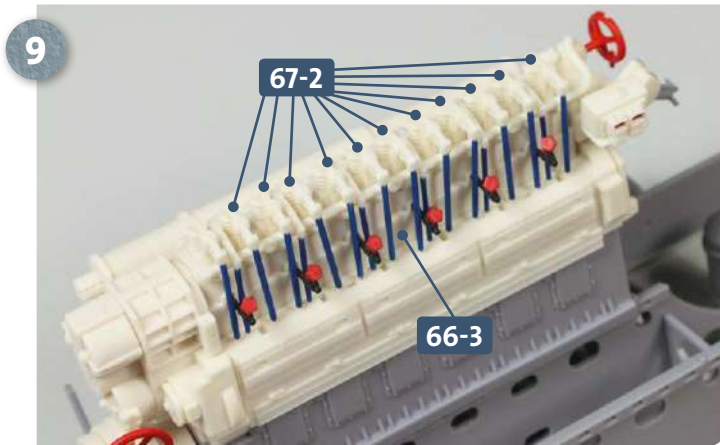

Repeat the process with the remaining 11 parts **67-2**. These are glued in the adjacent slots at the top of the cylinder cover **66-3**, as indicated above.

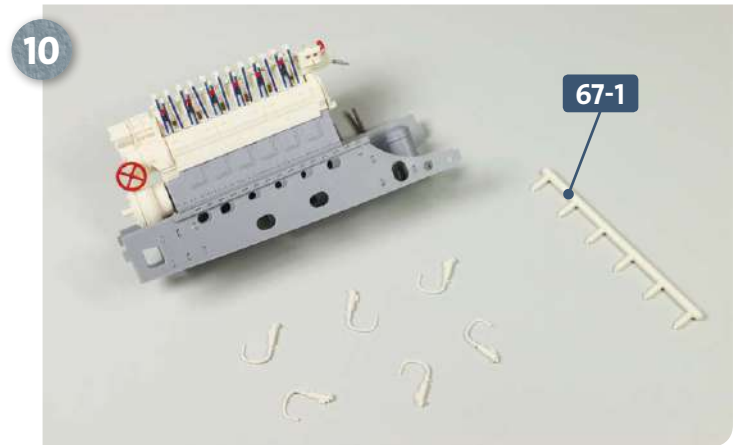

Before starting this step, read through the next three steps to see how these parts are fitted. Then separate the six fuel oil pumps from frame **67-1**.

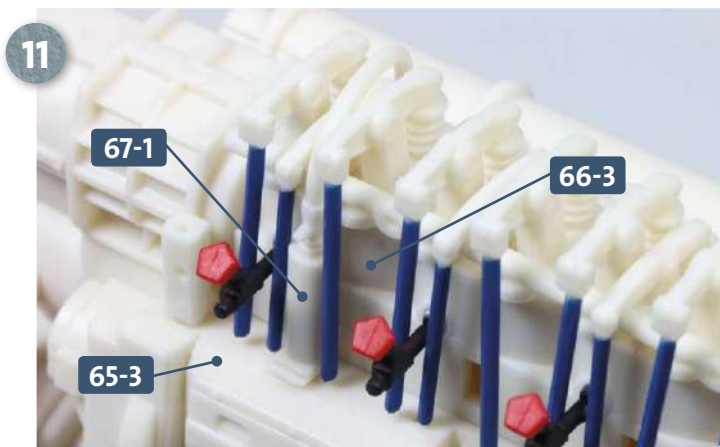

Taking the first fuel oil pump **67-1**, apply some glue to the two rectangular pegs at the wide end of the piece: one of these is inserted into the slot on the cylinder cover **66-3**, the other into the slot in the engine block **65-3**.

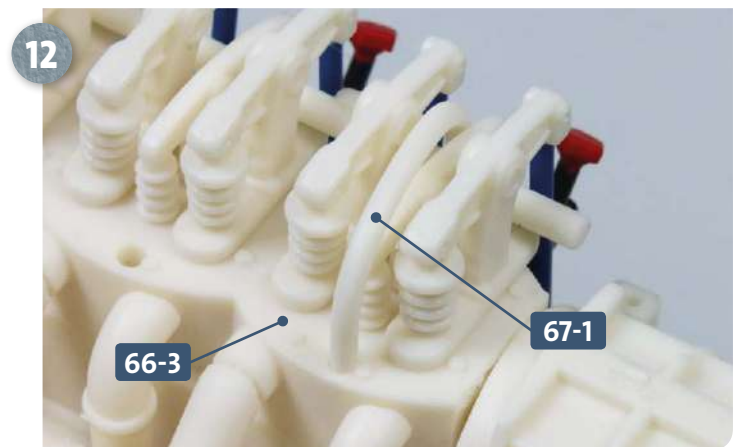

This photograph shows the view from the other side of the engine: the narrow end of the fuel oil pump **67-1** is glued into the round hole at the top of the cylinder cover **66-3**.

Kit 67: The engine room (IV)

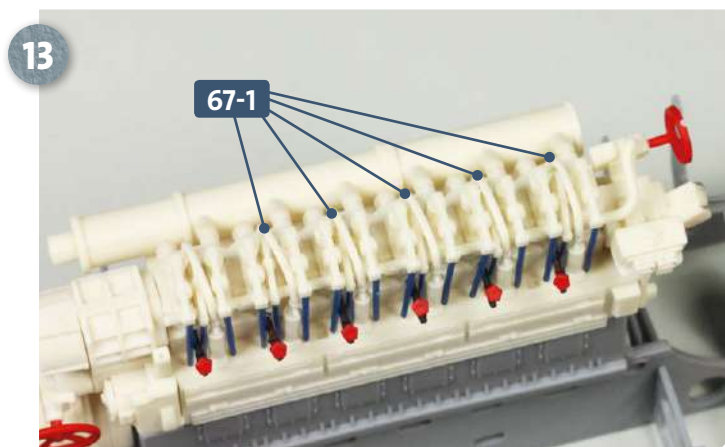

13 Repeat the process with the five remaining fuel oil pumps 67-1: these are attached in sequence to the cylinder cover and engine block, as pictured.

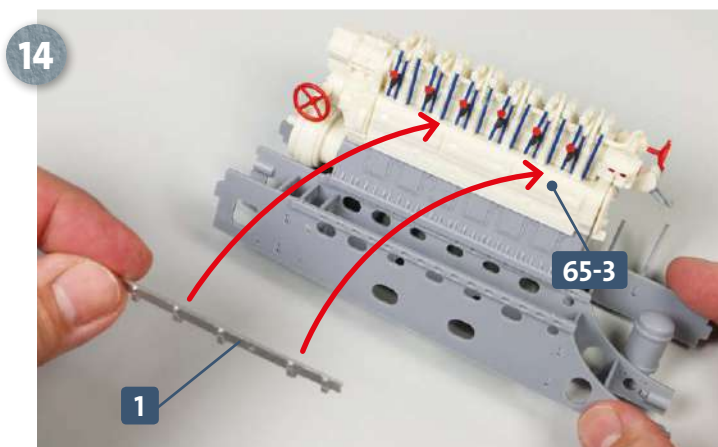

14 Separate the control linkage 1 from frame 67-5. Apply some glue to the two slightly longer pegs and insert these into the two rectangular holes on the engine block 65-3, as indicated by the two arrows.

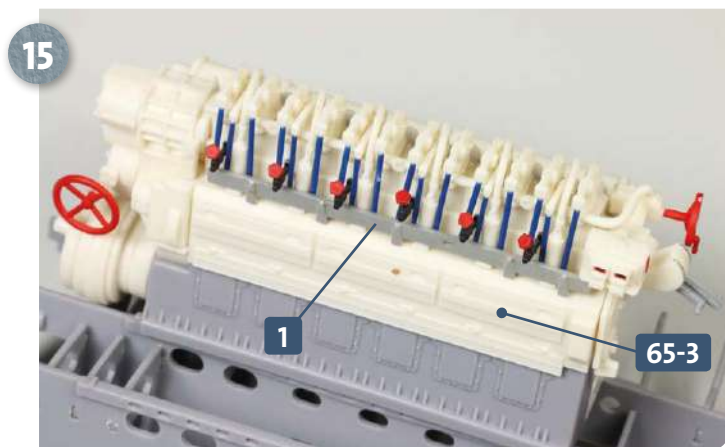

15 This photograph shows the control linkage 1 attached to the engine block 65-3.

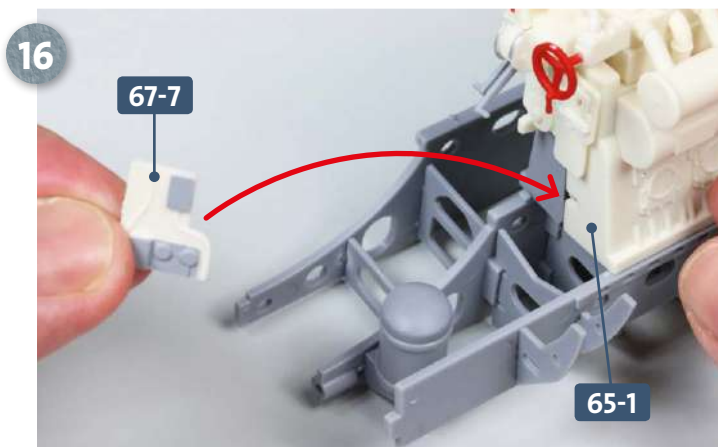

16 Now, working at the forward end of the engine, take attachment part 67-7, apply some glue to the small peg on the back, and fit it into the recess in the engine block 65-1, as shown.

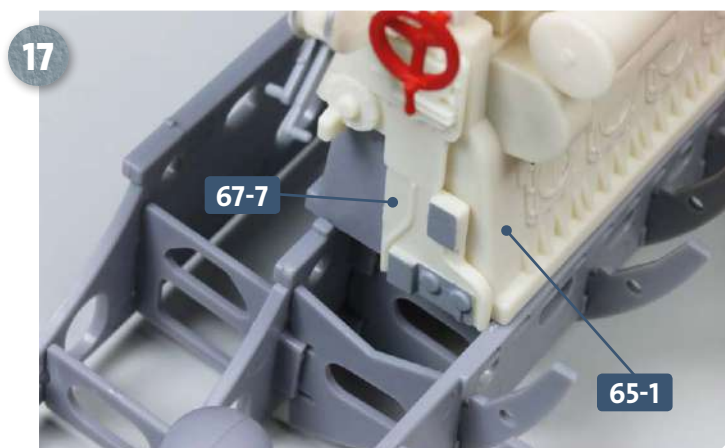

17 Press the peg of attachment 67-7 fully into the recess in the engine block 65-1.

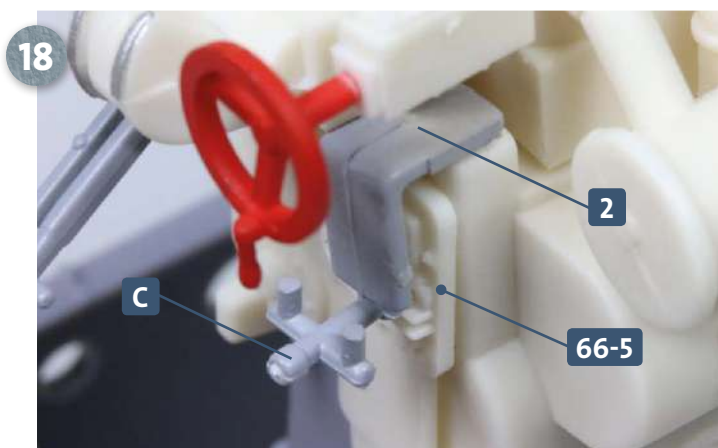

18 Detach part C from frame 67-6 and attachment 2 from frame 67-5. Both parts need to be glued into the holes in attachment 66-5. Study the photograph carefully to ensure the parts are fitted in the correct position.

Kit 67: The engine room (IV)

19

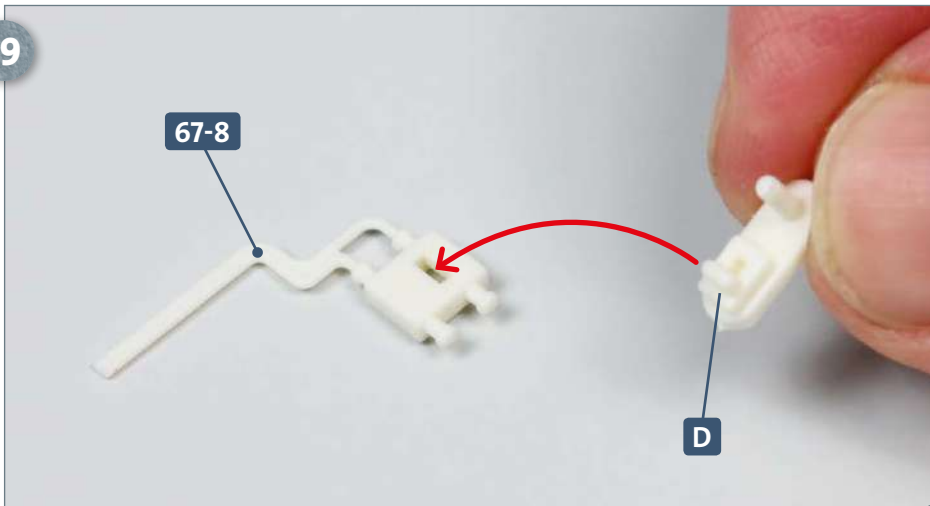

Separate the revolution counter from frame 67-6. Apply some glue to the back of the rectangular peg and insert it into the slot on attachment 67-8, as indicated by the arrow. Pay attention to the alignment of the revolution counter.

20

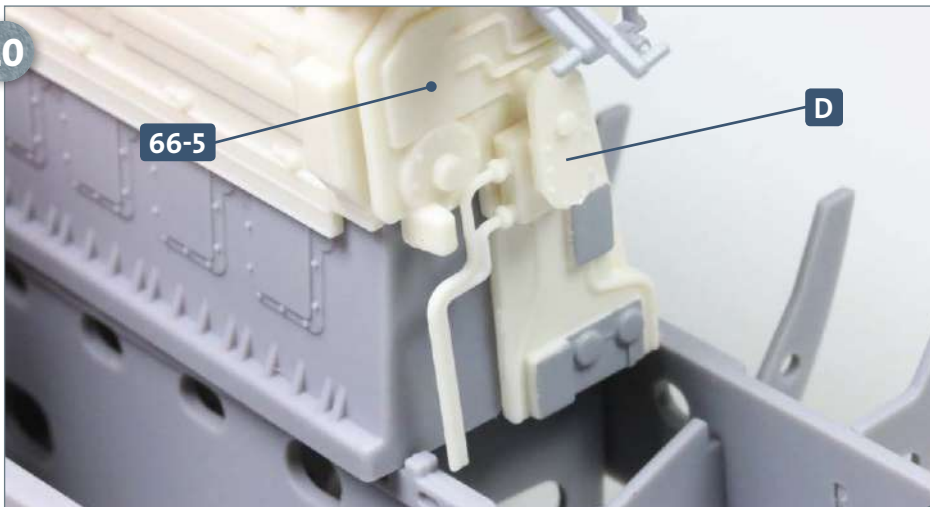

Attach the assembly you have just made in the previous step to attachment 66-5: to do this, insert the round peg at the back of D into the free hole in the attachment. See photo, left.

COMPLETED WORK

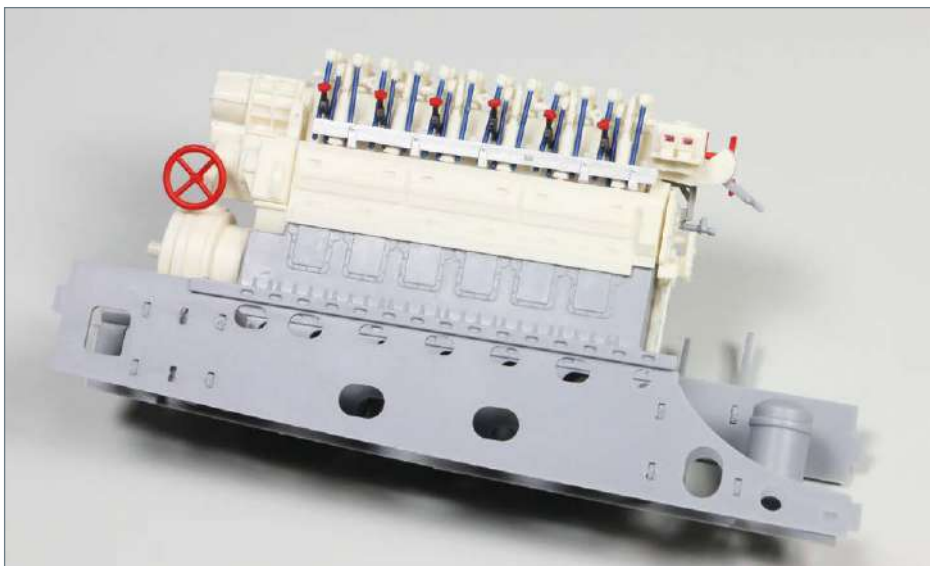

Various small parts have now been attached to the cylinder cover, and the exhaust manifold has been installed.

Kit 68: Engine room forward bulkhead

In this kit, you will assemble two fuel oil collection bunkers, which you will then mount on the forward bulkhead of the engine room, in addition to various switch boxes and other attachments.

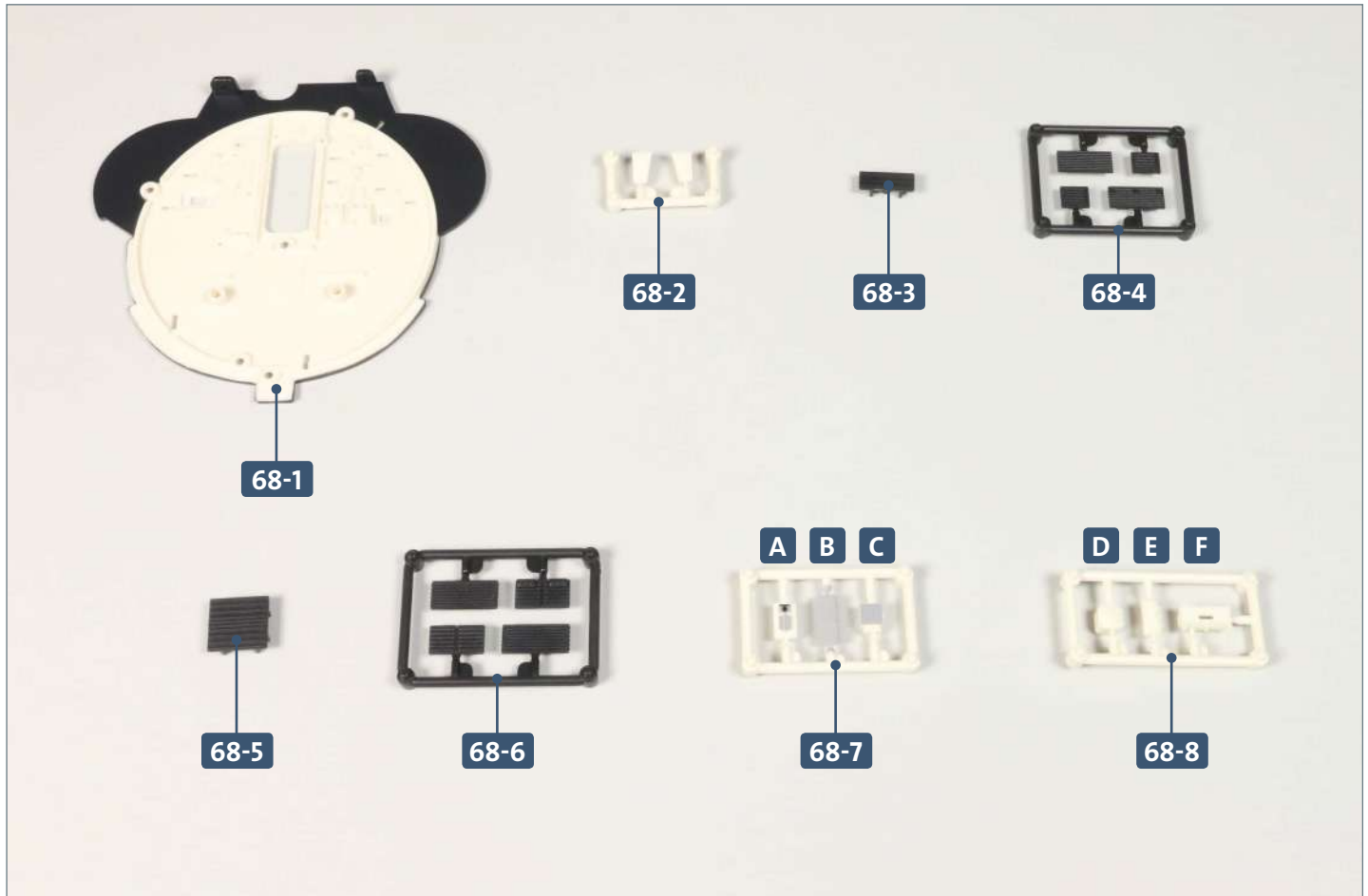

Parts reference list

Part no.	Name
68-1	Forward bulkhead
68-2	Attachments
68-3	Small fuel oil bunker
68-4	Small bunker sides
68-5	Large fuel oil bunker
68-6	Large bunker sides
68-7	Frame with switch boxes (A, B, C)
68-8	Frame with switch boxes (D, E, F)

STAGE 1 → Engine room forward bulkhead

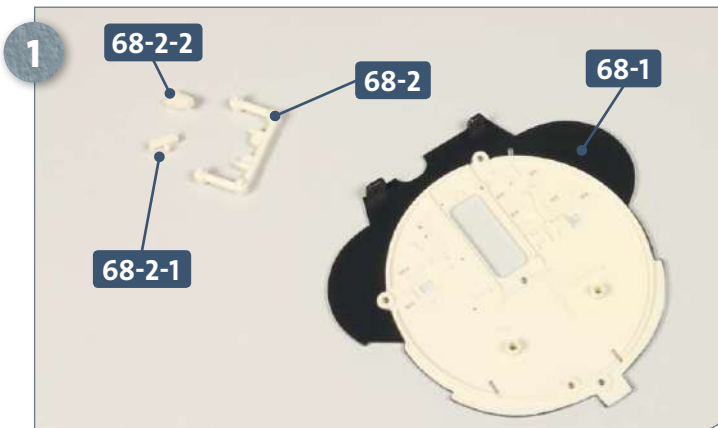

Place the forward bulkhead **68-1** and frame **68-2** on your work surface. Remove both attachments **68-2-1** and **68-2-2** from the frame.

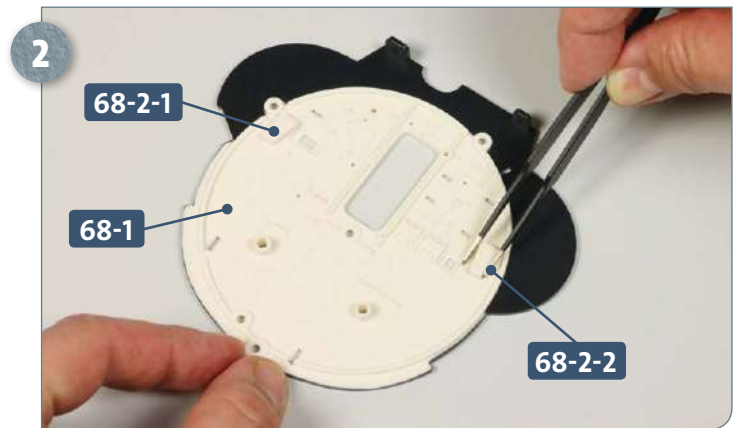

Glue attachments **68-2-1** and **68-2-2** to the forward bulkhead **68-1**, as shown above.

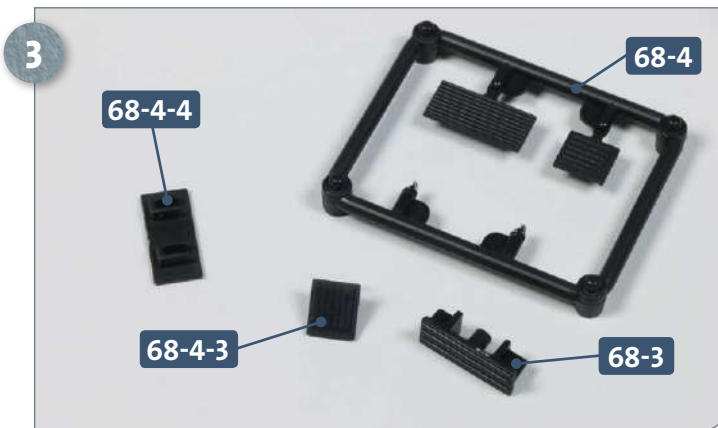

Now take the small fuel oil bunker **68-3** and the frame with its sides **68-4**. Separate the sides **68-4-3** and **68-4-4** from the frame.

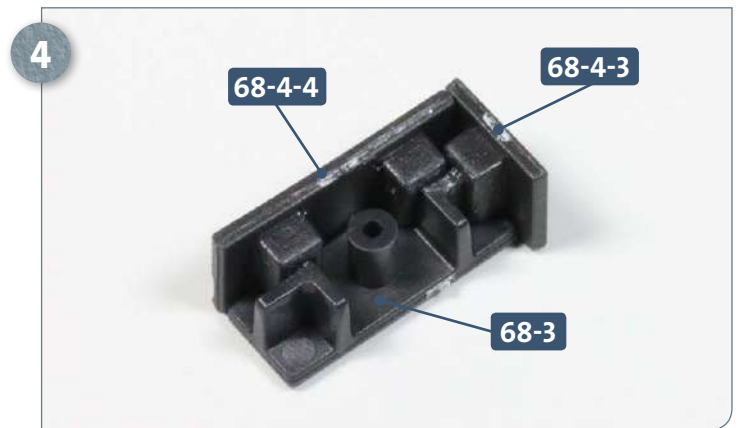

Attach the sides **68-4-3** and **68-4-4** to the fuel oil bunker **68-3** with a little glue.

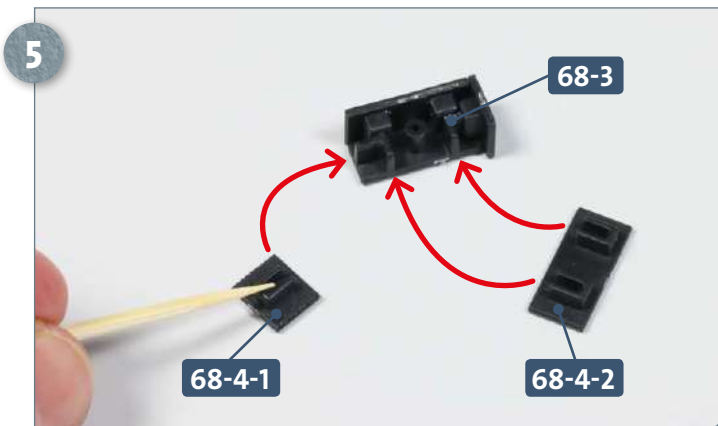

Detach sides **68-4-1** and **68-4-2** from frame **68-4**. Apply some glue to the sides and attach them to the bunker **68-3**, as indicated by the arrows.

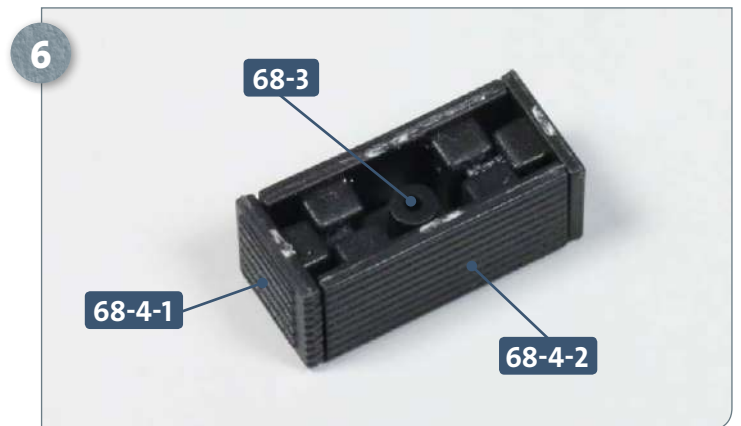

This photograph shows the small fuel oil collection bunker with sides attached.

Kit 68: Engine room forward bulkhead

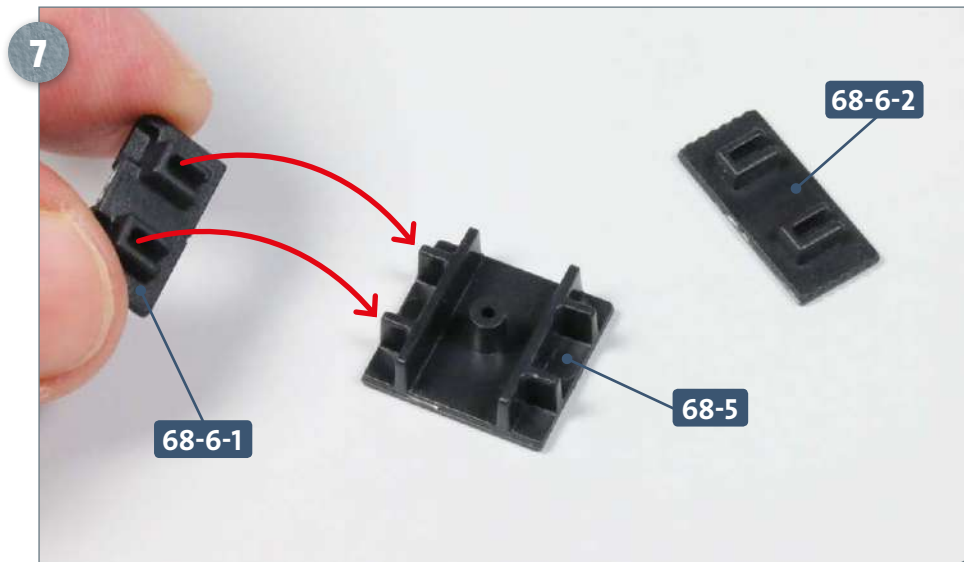

Lay the large fuel oil bunker **68-5** and the frame with its sides **68-6** on your work surface. Separate the sides **68-6-1** and **68-6-2** from the frame. Apply some glue to side **68-6-1** and attach it to the bunker as indicated, left.

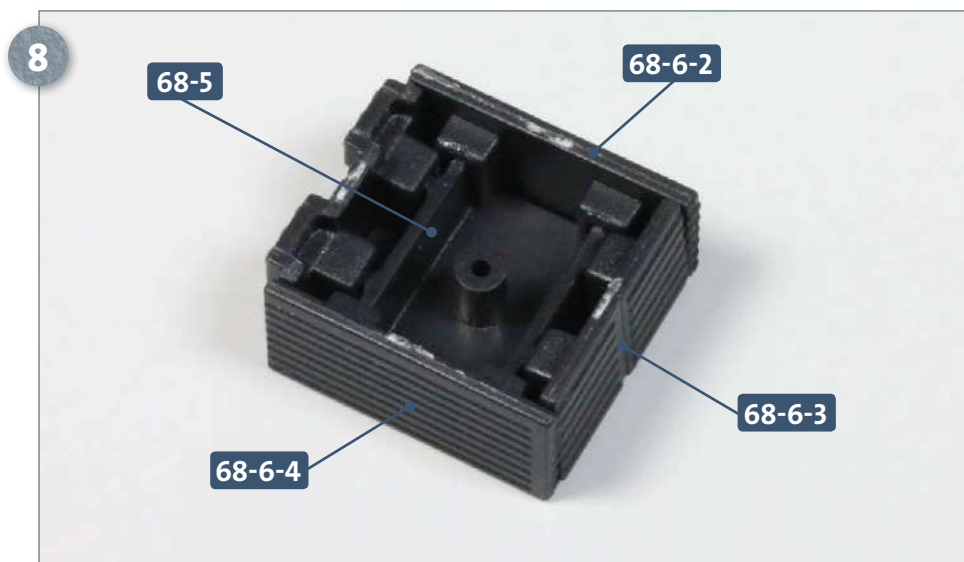

Next, glue side **68-6-2** to the bunker **68-5**. Detach sides **68-6-3** and **68-6-4** from frame **68-6** and glue these to the bunker, as shown.

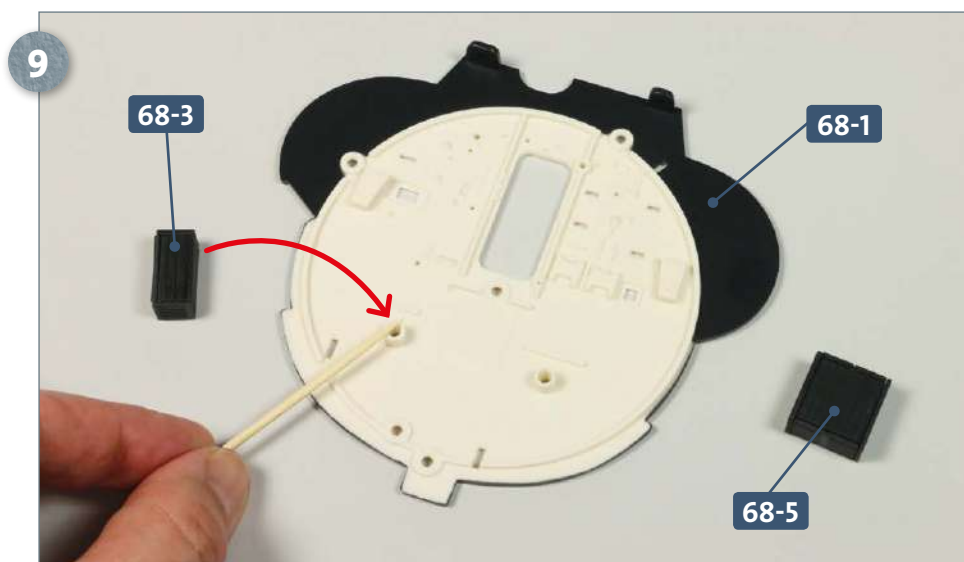

Place the two fuel oil collection bunkers **68-3** and **68-5** alongside the forward bulkhead **68-1**. Apply some glue to the peg of the bulkhead (indicated by the arrow). The small bunker **68-3** is then attached to the glued peg.

Kit 68: Engine room forward bulkhead

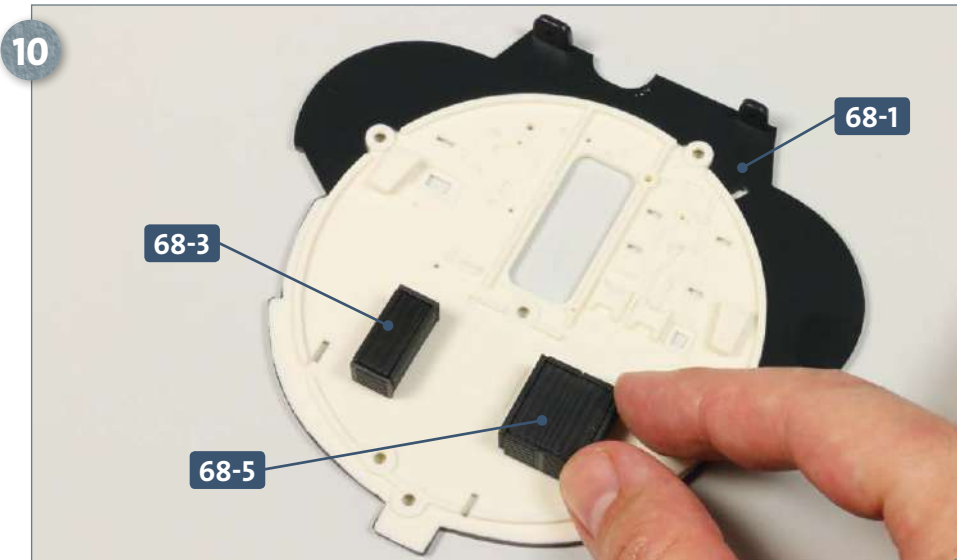

Now apply some glue to the right-hand peg on the bulkhead. The large fuel oil bunker **68-5** is glued to this, as pictured.

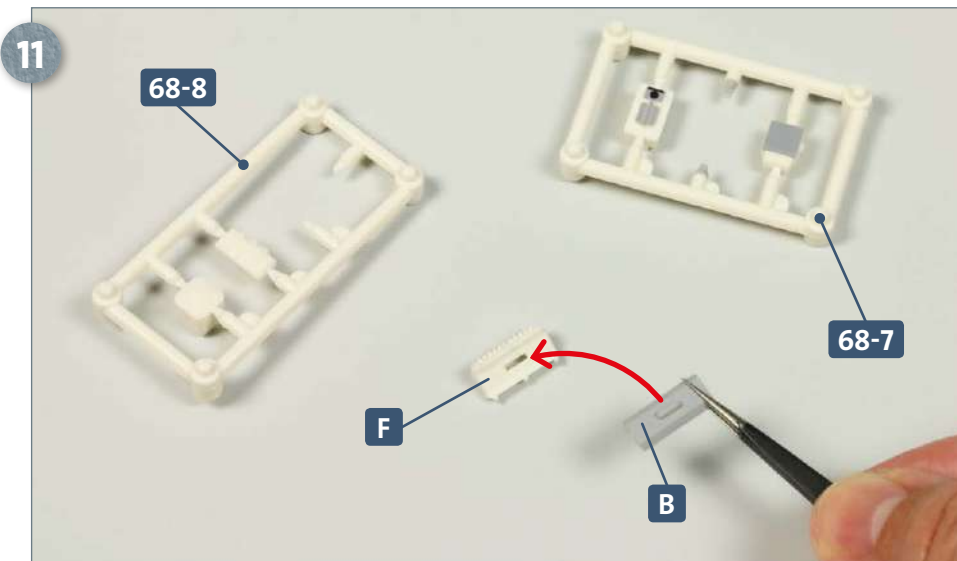

Take the two frames with the switch boxes, **68-7** and **68-8**, and detach parts **B** and **F**. Glue the two parts together as shown by the arrow.

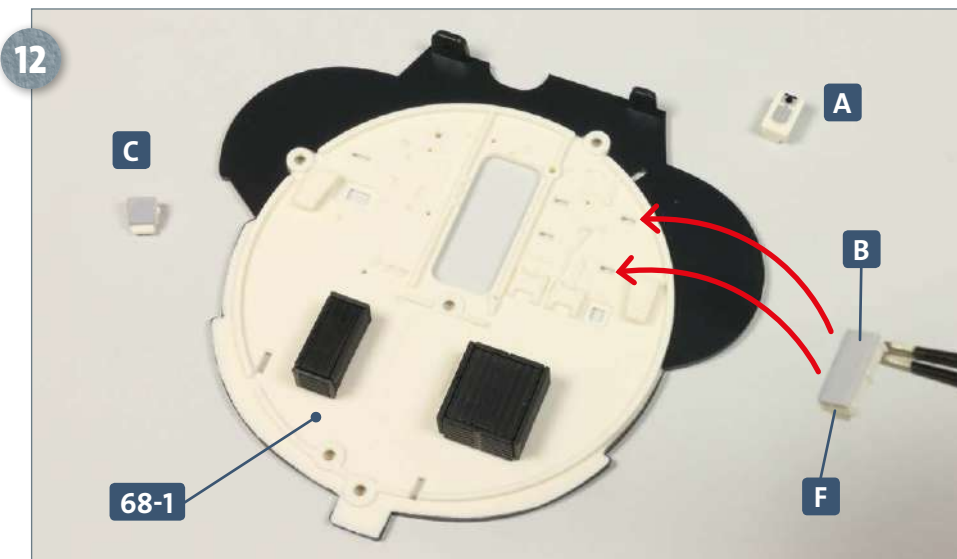

Apply some glue to the tabs on the bottom of the glued-together assembly **B/F** and attach it to the bulkhead **68-1**, as shown by the arrows. Remove parts **A** and **C** from frame **68-7**.

Kit 68: Engine room forward bulkhead

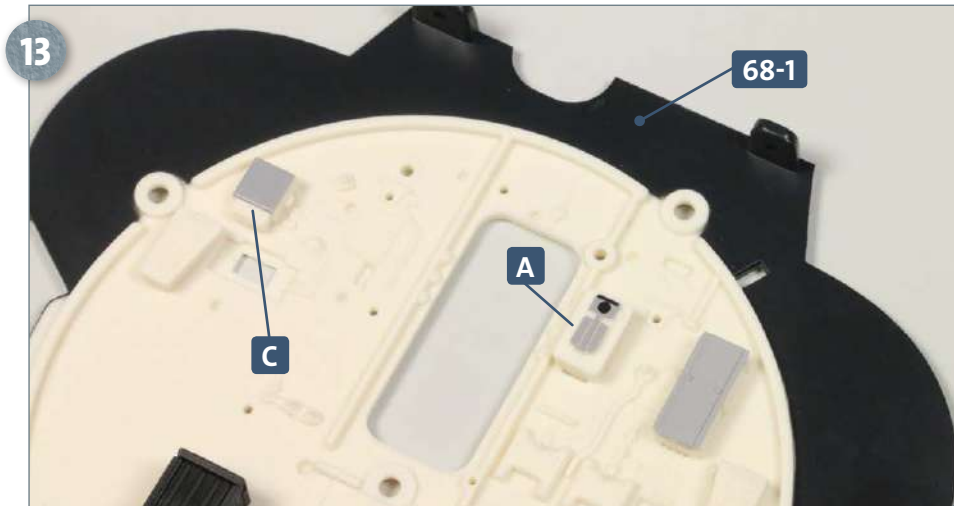

Glue parts A and C to the bulkhead 68-1, as pictured.

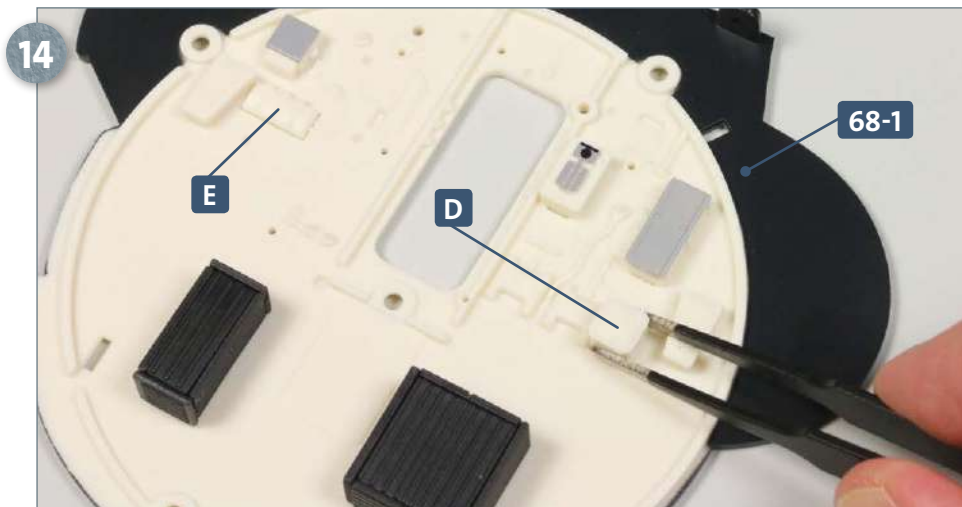

Remove parts D and E from frame 68-8 and glue them to the forward bulkhead 68-1, as pictured.

COMPLETED WORK



Two fuel oil collection bunkers have now been assembled and attached to the forward bulkhead of the engine compartment, along with other details.